

Contents

| | Page |
|--|--------------|
| Description of the Han-Modular® system | 06.03 |
| Summary Han-Modular® | 06.04 |
| Han-Modular® Compact | 06.08 |
| Han-Modular® Twin | 06.12 |
| Han-Modular® Hinged frames | 06.14 |
| Han-Modular® Docking frames | 06.16 |
| Han-Modular® ECO | 06.20 |
| Han® 200 A Axial module | 06.24 |
| Han® 200 A Crimp module | 06.26 |
| Han® 100 A Axial module | 06.28 |
| Han® 100 A Crimp module | 06.30 |
| Han® 100 A Single module | 06.32 |
| Han® 70 A Axial module | 06.34 |
| Han® 70 A Crimp module | 06.36 |
| Han® 40 A Axial module | 06.38 |
| Han® 40 A Crimp module | 06.40 |
| Han® C Axial module | 06.42 |
| Han® C module | 06.44 |
| Han® CC Protected module | 06.46 |
| Han® CD module | 06.48 |
| Han E® module | 06.50 |
| Han® EE module | 06.52 |
| Han® EE Quick Lock module | 06.54 |
| Han E® Protected module | 06.56 |
| Han® EEE module | 06.58 |
| Han® ES module | 06.60 |
| Han® HV module | 06.62 |
| Han DD® module | 06.66 |

| | |
|---|---------------|
| Han DD® Quick Lock module | 06.68 |
| Han® DDD module | 06.70 |
| Han® High Density module | 06.72 |
| Han® D-Sub module | 06.74 |
| Han® USB module | 06.76 |
| Han® FireWire module | 06.78 |
| Han® RJ45 module | 06.80 |
| Han® GigaBit module | 06.86 |
| Han-Quintax® module | 06.90 |
| Han® Coax module | 06.92 |
| Han® Multi module according to DIN 41 626 | 06.94 |
| Han® Multi module according to D-Sub | 06.96 |
| Han® Multi module | 06.98 |
| Han® Pneumatic module | 06.100 |
| Han® SC module | 06.104 |
| Han-Elisa® | 06.106 |
| Han-Elisa® Pt100 Modul | 06.108 |
| Han-Elisa® Output module | 06.110 |
| Han-Elisa® ID module | 06.112 |
| Han-Modular® Accessories | 06.114 |

Description of the Han-Modular® system

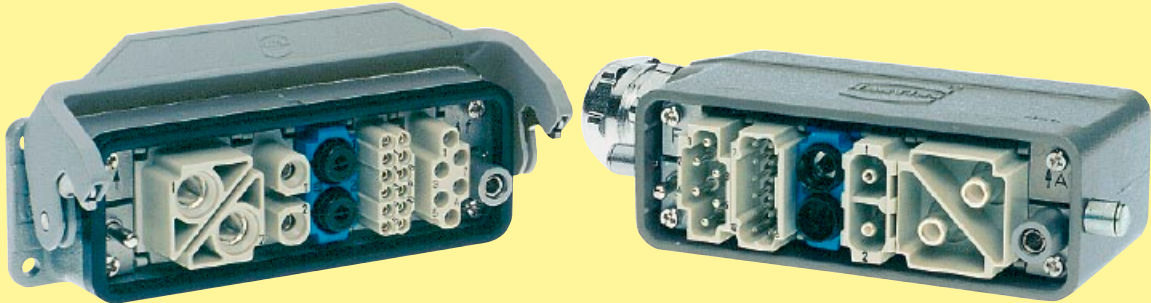

The Han-Modular® series is a new system of inserts designed to meet the specific requirements of individual customers. In close cooperation with potential users a range of modular inserts have been developed allowing the simple assembly of custom designed complete connectors which meet the diverse requirements encountered by designers today.

Han-Modular® is a logical development of the Han-Com® series which already offers the combination of power and signal circuits in one connector.

The individual modules of this series now allow the integration of electrical, optical and gaseous signal and power connections in one connector assembly.

The pneumatic contacts are also suitable for the connection of liquid media. However it must be stated that a combination of electrical and liquid connections in one connector is not allowed according to VDE regulations.

The individual contacts used in this system are all from existing well proven ranges and it is possible to use combinations of 1 to 12 modules depending on the size of the hoods and housings chosen.

The basic modules snap into a mounting frame and can be exchanged separately at any time.

Advantages:

- Custom designs can be simply assembled
- Optimum solutions can be reached
- Stock can be minimized

Assembly details

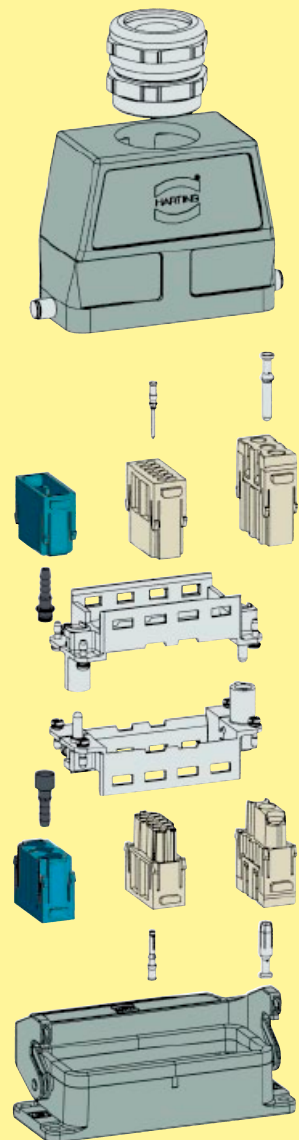

Han-Modular® Compact

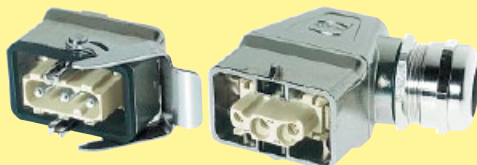

Page 06.08

Han-Modular® Twin



Page 06.12

Han-Modular® Hinged frames in Han® B hoods and housings

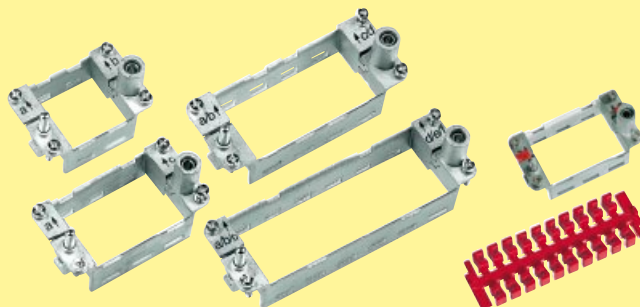

Page 06.14

Han-Modular® Docking frame

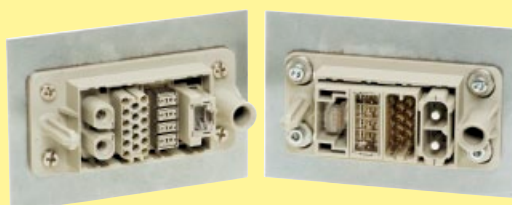









Page 06.16

Han-Modular® ECO











Page 06.20





| Series | Han® 200 A Axial module | Han® 200 A Crimp module | Han® 100 A Axial module | Han® 100 A Crimp module |
|--------------------|---|---|--|---|
| Number of contacts | 1 | 1 | 2 | 2 |
| Modules | Axial screw terminal  | Crimp terminal  | Axial screw terminal  | Crimp terminal  |
| Rated current | 200 A | 200 A | 100 A | 100 A |
| Rated voltage | 1000 V | 1000 / 1000 V | 1000 V | 1000 V |
| Wire gauge | 25 ... 70 mm ² | 25 ... 70 mm ² | 10 ... 38 mm ² | 10 ... 35 mm ² |
| Page | 06.24 | 06.26 | 06.28 | 06.30 |

| Series | Han® 100 A Single module | Han® 70 A Axial module | Han® 70 A Crimp module | Han® 40 A Axial module |
|--------------------|---|---|--|---|
| Number of contacts | 1 | 2 | 2 | 2 |
| Modules | Crimp terminal  | Axial screw terminal  | Crimp terminal  | Axial screw terminal  |
| Rated current | 100 A | 70 A | 70 A | 40 A |
| Rated voltage | 830 V | 1000 V | 1000 V | 1000 V |
| Wire gauge | 10 ... 35 mm ² | 6 ... 22 mm ² | 10 ... 25 mm ² | 2.5 ... 10 mm ² |
| Page | 06.32 | 06.34 | 06.36 | 06.38 |



Han
Modular



| Series | Han® 40 A Crimp module | Han® C Axial module | Han® C module | Han® CC Protected module |
|--------------------|---|---|--|---|
| Number of contacts | 2 | 3 | 3 | 4 |
| Modules | Crimp terminal  | Axial screw terminal  | Crimp terminal  | Crimp terminal  |
| Rated current | 40 A | 40 A | 40 A | 40 A |
| Rated voltage | 1000 V | 690 V | 400 / 690 V | 830 V |
| Wire gauge | 1.5 ... 10 mm ² | 2.5 ... 10 mm ² | 1.5 ... 10 mm ² | 1.5 ... 6 mm ² |
| Page | 06.40 | 06.42 | 06.44 | 06.46 |



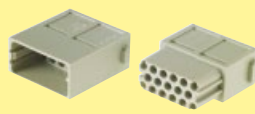

| Series | Han® CD module | Han E® module | Han® EE module | Han® EE Quick Lock module |
|--------------------|---|---|--|--|
| Number of contacts | 3 / 4 | 6 | 8 | 8 |
| Modules | Crimp terminal  | Crimp terminal  | Crimp terminal  | Quick Lock terminal  |
| Rated current | 40 A / 10 A | 16 A | 16 A | 16 A |
| Rated voltage | 830 V / 830 V | 500 V | 400 V | 400 V |
| Wire gauge | 1.5 ... 6 mm ² / 0.14 ... 2.5 mm ² | 0.14 ... 4 mm ² | 0.14 ... 4 mm ² | 0.5 ... 2.5 mm ² |
| Page | 06.48 | 06.50 | 06.52 | 06.54 |



















| Series | Han E® Protected module | Han® EEE module | Han® ES module | Han® HV module |
|--------------------|---|---|---|---|
| Number of contacts | 6 | 20 | 5 | 2 |
| Modules | Crimp terminal  | Crimp terminal  | Cage-clamp terminal  | Crimp terminal  |
| Rated current | 16 A | 16 A | 16 A | 16 A |
| Rated voltage | 830 V | 500 V | 400 V | 2900 / 5000 V |
| Wire gauge | 0.14 ... 4 mm ² | 0.14 ... 4 mm ² | 0.14 ... 2.5 mm ² | 0.5 ... 4 mm ² |
| Page | 06.56 | 06.58 | 06.60 | 06.62 |

Han Modular

| Series | Han® HV module | Han DD® module | Han DD® Quick Lock module | Han® DDD module |
|--------------------|---|---|---|---|
| Number of contacts | 2 | 12 | 12 | 17 |
| Modules | Crimp terminal  | Crimp terminal  | Quick Lock terminal  | Crimp terminal  |
| Rated current | 40 A | 10 A | 10 A | 10 A |
| Rated voltage | 2900 / 5000 V | 250 V | 250 V | 160 V |
| Wire gauge | 1.5 ... 10 mm ² | 0.14 ... 2.5 mm ² | 0.25 ... 1.5 mm ² | 0.14 ... 2.5 mm ² |
| Page | 06.64 | 06.66 | 06.68 | 06.70 |

| Series | Han® High Density module | Han® D-Sub module | | |
|--------------------|---|---|--|--|
| Number of contacts | 25 | 9 | | |
| Modules | Crimp terminal  | Crimp terminal  | | |
| Rated current | 4 A | 5 A | | |
| Rated voltage | 50 V | 50 V | | |
| Wire gauge | 0.08 ... 0.52 mm ² | 0.08 ... 0.52 mm ² | | |
| Page | 06.72 | 06.74 | | |

| Series | Han® USB module | Han® FireWire module | Han® RJ45 module | Han® GigaBit module |
|--------------------|--|--|---|---|
| Number of contacts | 4 | 6 | 8 | 8 |
| Modules | USB 2.0  | IEEE 1394  | Ethernet Cat. 6  | Ethernet Cat. 6 _A  |
| Page | 06.76 | 06.78 | 06.80 | 06.86 |

| | | | | |
|--------------------|--|--|---|--|
| Series | Han-Quintax® module | | | |
| Number of contacts | 2 | | | |
| Modules |  | | | |
| Page | 06.90 | | 06.92 | |
| Contacts | Han-Quintax® contact 4 + shielding  | High Density Quintax contact 8 + shielding  | Han D® Coax contact 1 + shielding 75 Ω  | Han E® Coax contact 1 + shielding 50 Ω  |
| Series | Han® Multi module | | | |
| Number of contacts | 4 | | 12 | |
| Modules |  | |  | |
| Page | 06.94 | | 06.96 | |
| Contacts | FOC contacts  Multimode F.O. HCS®* / PCF F.O. 1 mm POF | Coaxial contacts  50 Ω RG 174 75 Ω RG 179 50 Ω RG 58 | FOC contacts  Multimode F.O. HCS®* / PCF F.O. 1 mm POF | Coaxial contacts  50 Ω RG 174 75 Ω RG 179 |
| Series | Han® Pneumatic module | | | |
| Number of contacts | 2 | 3 | | |
| Modules |  |  | | |
| Page | 06.100 | | 06.102 | |
| Contacts |  Ø 6.0 mm |  Ø 1.6 mm Ø 3.0 mm Ø 4.0 mm | | |
| Series | Han® SC module | Han-Elisa® | Dummy module | |
| Number of contacts | 4 | | | |
| Modules |  |  |  | |
| Page | 06.104 | 06.106 | 06.114 | |
| Contacts | SC contact for GI 50; 62.5 / 125 µm  | Temperature I/O modules ID module | | |

* HCS® = Hard Clad Silica (is registered trade mark of the SpecTran Corporation)

Features

- Compact design saves space
- Modular structure increases flexibility
- Simple and quick assembly
- Robust design
- Two part grommet housing

Technical characteristics

Hoods/Housings

| | |
|--|----------------------------|
| Material | zinc die-cast |
| Surface | nickel plated |
| Locking element | stainless steel |
| Hoods/Housings sealing | NBR |
| Limiting temperatures | -40 °C ... +125 °C |
| Degree of protection acc. to DIN EN 60 529 | |
| for coupled connector | IP 65 |
| Mechanical working life | |
| - mating cycles | 500 |
| PE contact | |
| wire gauge | 10 mm ² / AWG 8 |
| Stripping length | 10 mm |
| Tightening torque | 1 Nm |

Protection covers for housings, bulkhead mounting

| | |
|--|--------------------|
| Material | polycarbonate |
| Locking element | Polyamide |
| Hoods/Housings sealing | NBR |
| Limiting temperatures | -40 °C ... +125 °C |
| Degree of protection acc. to DIN EN 60 529 | |
| for coupled connector | IP 65 |
| Flammability acc. to UL 94 | V 0 |

Current carrying capacity

The current carrying capacity of the connectors is limited by the thermal load capability of the contact element material including the connections and the insulating parts. The derating curve is therefore valid for currents which flow constantly (non-intermittent) through each contact element of the connector evenly, without exceeding the allowed maximum temperature.

Measuring and testing techniques according to DIN EN 60 512-5

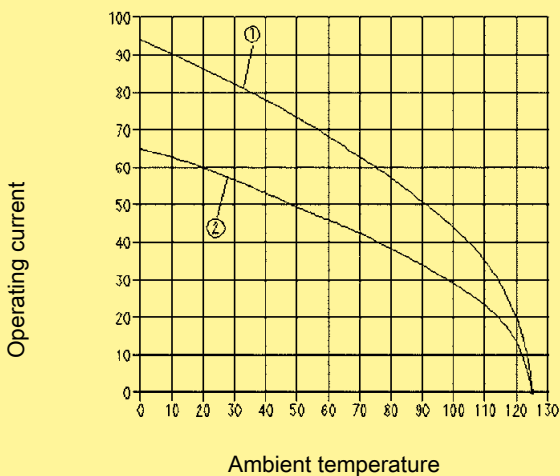

① Han® 40 A Axial module, wire gauge: 10 mm²

② Han® C module, wire gauge: 6 mm²

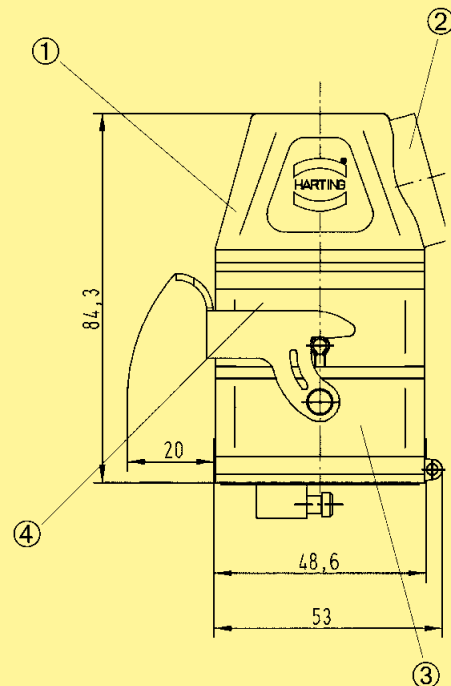





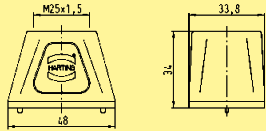

① Hood with side entry

② Thread M25

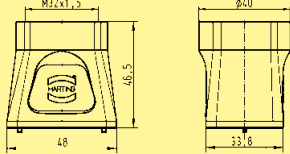
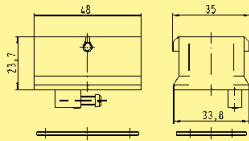
③ Bulkhead mounted housing with locking lever

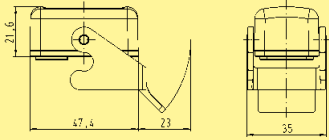
④ Carrier hood

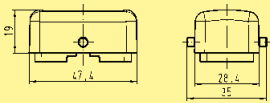
| Identification | Part number | Drawing | Dimensions in mm |
|--|-----------------------|---|------------------|
| Hoods side entry M25  | 19 14 001 0501 | 4 screws are included in the delivery range  | |
| Hoods top entry M25  | 19 14 001 0401 | 4 screws are included in the delivery range  | |
| Hoods top entry M32  | 19 14 001 0402 | 4 screws are included in the delivery range  | |
| Carrier hood  | 09 14 001 0311 |  | |
| Protection covers  | 09 14 001 5402 |  | |
| Housings, bulkhead mounting  | 09 14 001 0301 |  | Panel cut out |
| Protection covers for housings, bulkhead mounting  | 09 14 001 5401 |  | |

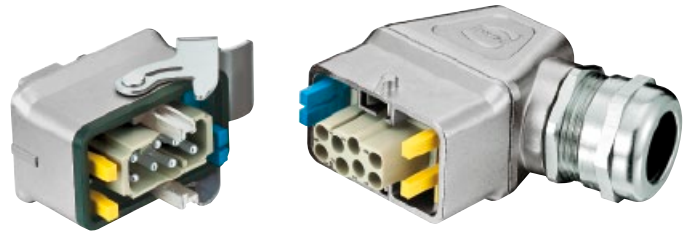

Coding pins

Han
Modular

| Identification | Part number | Drawing | Dimensions in mm |
|----------------|-------------|---------|------------------|
|----------------|-------------|---------|------------------|

Coding pin 1 (red)



09 14 000 9971

Coding pin 2 (blue)



09 14 000 9972

Coding pin 3 (black)



0914 000 9973

Coding pin 4 (yellow)



09 14 000 9974

16 Coding options

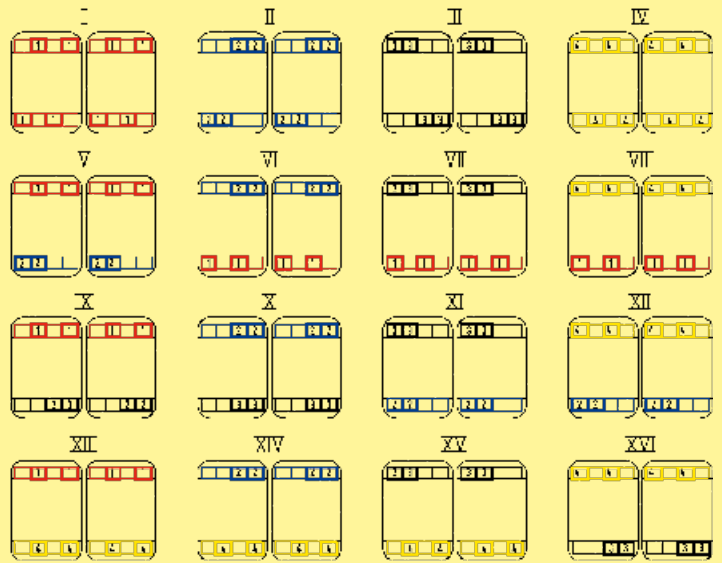



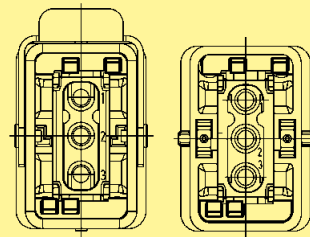

Example for coding option IV



Remark

Coding pins can be retro fitted from the front.

-  09 14 000 9971 red
-  09 14 000 9972 blue
-  09 14 000 9973 black
-  09 14 000 9974 yellow

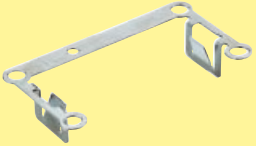
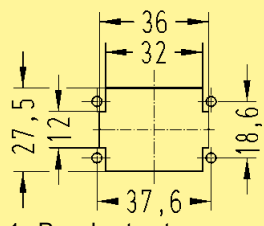
| Identification | Part number | Drawing | Dimensions in mm |
|--|------------------------------|---|------------------|
| <p>Fixing bracket for Han-Modular® Compact</p>  | <p>09 14 000 9947</p> |  <p>1 Panel cut out</p> | |
| | | | |

Han
Modular

Features

- Compact and space saving
- High degree of flexibility due to modular assembly
- Easy and quick assembly
- Robust design
- Hood consists of two parts

Technical characteristics

Hoods/Housings

| | |
|--|----------------------------|
| Material | aluminium die-cast |
| Surface | powder-coated |
| Locking element | Han-Easy Lock® |
| Material | |
| Panel feed through housing / Shielding frame | zinc die-cast |
| Hoods/Housings seal | NBR |
| Limiting temperatures | -40 °C ... +125 °C |
| Degree of protection acc. to DIN EN 60 529 | |
| for coupled connector | IP 65 |
| Mechanical working life | |
| - mating cycles | ≥ 500 |
| PE contact | |
| wire gauge | 10 mm ² / AWG 8 |
| Stripping length | 10 mm |
| Tightening torque | 1 Nm |

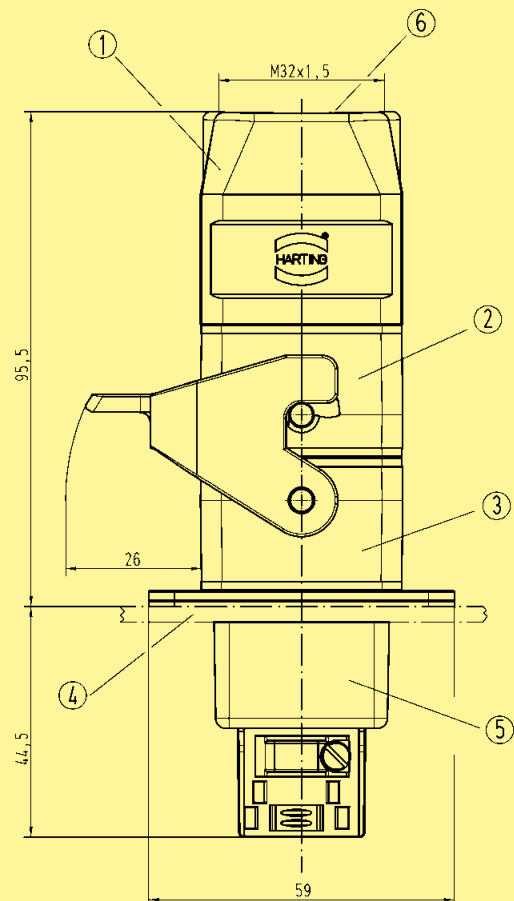

- ① Hood with top entry
- ② Carrier hood
- ③ Bulkhead mounted housing with locking lever
- ④ Switch board panel
- ⑤ Panel feed through housing
- ⑥ Thread M32



| Identification | Part number | Drawing | Dimensions in mm |
|------------------------------------|-----------------------|---------|----------------------|
| Hoods top entry M32 | 19 14 002 0402 | | |
| Shielding frame | 09 14 000 9924 | | |
| Carrier hood | 09 14 002 0311 | | |
| Housings, bulkhead mounting | 09 14 002 0301 | | Panel cut out |
| Panel feed through housings | 09 14 000 9928 | | Panel cut out |

Features

- Pre-leading grounding system according VDE
- Modules can only be assembled polarized to guarantee a correct orientation
- Alphabetical marking of module position
- High mechanical reliability of modules in case of vibration and impact stress
- No tools necessary to remove modules

Technical characteristics

Specifications DIN EN 60 664-1
 DIN EN 61 984

Approvals 

Hinged frames

Number of modules 2, 3, 4, 6
 PE contact
 Wire gauge
 - Power side * 4 ... 10 mm²
 AWG 12 ... 8
 - Signal side 1 ... 2.5 mm²
 AWG 18 ... 14
 Material zinc die-cast
 Limiting temperatures -40 °C ... +125 °C
 Mechanical working life
 - mating cycles ≥ 500





Hoods/Housings

Selection of hoods/housings see chapter 30 / chapter 31
 Material aluminium die-cast
 Surface powder-coated
 RAL 7037
 Locking element Han-Easy Lock®
 Hoods/Housings seal NBR
 Limiting temperatures -40 °C ... +125 °C
 Degree of protection acc. to DIN EN 60 529
 for coupled connector IP 65

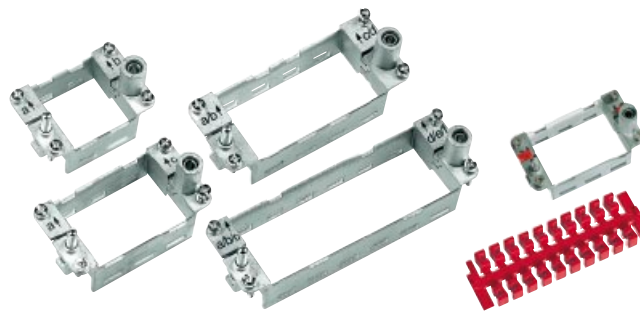
Accessories

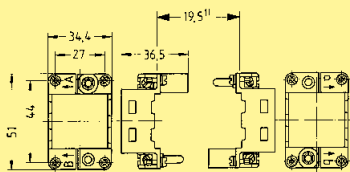
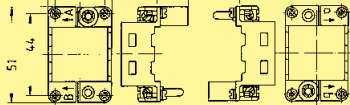
Coding of hoods/housings chapter 40

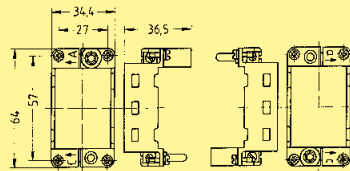
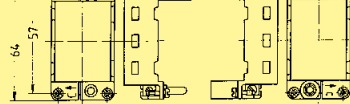

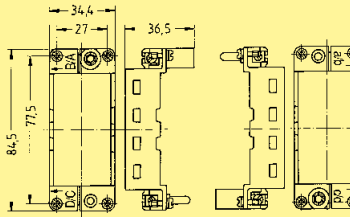
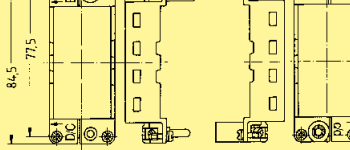
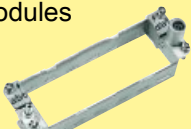
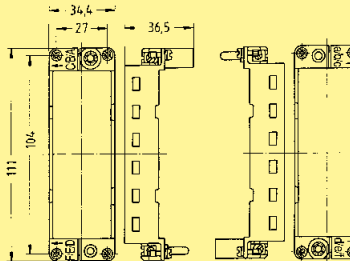
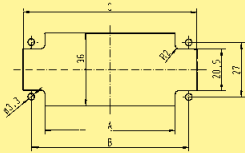
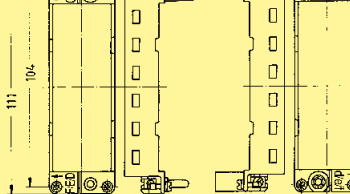
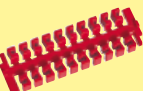
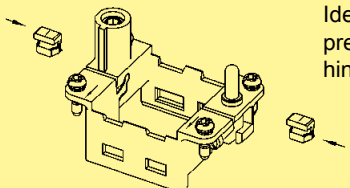
| Identification | Part number for Hood/Housing 2) | | | Drawing | Dimensions in mm | | | | | | | | | | | | | | | | | | | | |
|---|---------------------------------|-----------------------|-----------------------|---|--|---|---|---|------------|----|----|----|-------------|----|----|----|-------------|----|------|------|-------------|----|-----|-----|--|
| | Size | Marking A ... F | Marking a ... f | | | | | | | | | | | | | | | | | | | | | | |
| Hinged frame for 2 modules  | 6 B | 09 14 006 0303 | 09 14 006 0313 | Hoods  | Housings  | | | | | | | | | | | | | | | | | | | | |
| Hinged frame for 3 modules  | 10 B | 09 14 010 0303 | 09 14 010 0313 |  |  | | | | | | | | | | | | | | | | | | | | |
| Hinged frame for 4 modules  | 16 B | 09 14 016 0303 | 09 14 016 0313 |  |  | | | | | | | | | | | | | | | | | | | | |
| Hinged frame for 6 modules  | 24 B | 09 14 024 0303 | 09 14 024 0313 |  Panel cut out  <table border="1" data-bbox="991 1727 1465 1883"> <thead> <tr> <th>Size</th> <th>A</th> <th>B</th> <th>C</th> </tr> </thead> <tbody> <tr> <td>6 B</td> <td>35</td> <td>44</td> <td>52</td> </tr> <tr> <td>10 B</td> <td>49</td> <td>57</td> <td>66</td> </tr> <tr> <td>16 B</td> <td>64</td> <td>77.5</td> <td>85.5</td> </tr> <tr> <td>24 B</td> <td>94</td> <td>104</td> <td>112</td> </tr> </tbody> </table> | Size | A | B | C | 6 B | 35 | 44 | 52 | 10 B | 49 | 57 | 66 | 16 B | 64 | 77.5 | 85.5 | 24 B | 94 | 104 | 112 |  |
| Size | A | B | C | | | | | | | | | | | | | | | | | | | | | | |
| 6 B | 35 | 44 | 52 | | | | | | | | | | | | | | | | | | | | | | |
| 10 B | 49 | 57 | 66 | | | | | | | | | | | | | | | | | | | | | | |
| 16 B | 64 | 77.5 | 85.5 | | | | | | | | | | | | | | | | | | | | | | |
| 24 B | 94 | 104 | 112 | | | | | | | | | | | | | | | | | | | | | | |
| Locking element for hinged frames (20 pieces per bloc)  | | 09 14 000 9960 | 09 14 000 9960 |  | Ideal to pre-assemble the hinged frames | | | | | | | | | | | | | | | | | | | | |

1) Distance max. 20.5 mm
 2) Hinged frames can be used either in hood or housing
 Both different markings must be used for one connector!

Features

- Blind mating connector system for drawer systems
- Direct panel mounting without housing
- Very robust design
- Solid pre-leading guid pins and float bushes
- Can be fixed with standard M4 screws

Notice:

Due the plastic material used in the docking frame without PE, the panel will need to be grounded separately





Technical characteristics

| | |
|----------------|----------------------------------|
| Specifications | DIN EN 60 664-1 DIN EN 61 984 |
|----------------|----------------------------------|

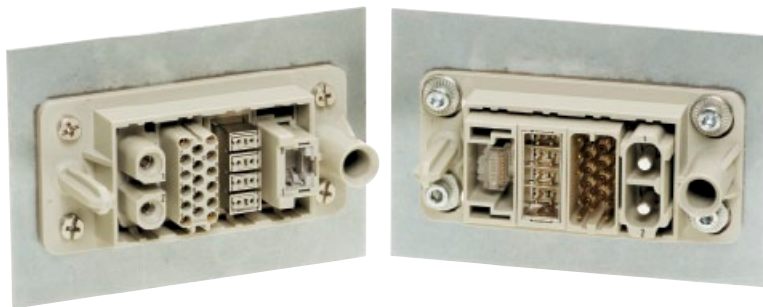
Docking frames

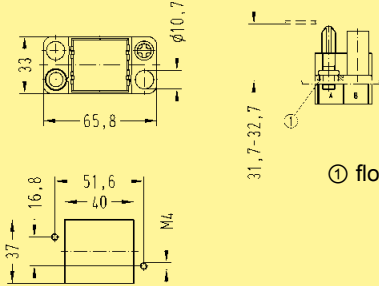
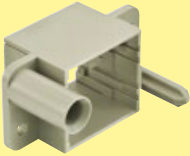
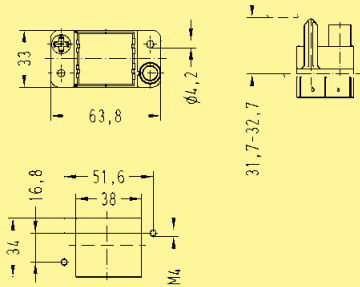
| | |
|----------------------------|--------------------|
| Number of modules | 2, 4, 6 |
| Material | |
| - Docking frames | polycarbonate |
| - Float washer | zinc die-cast |
| Floating tolerance | ± 2 mm |
| Aligning tolerance | ± 4 mm |
| Limiting temperatures | -40 °C ... +125 °C |
| Flammability acc. to UL 94 | V 0 |
| Mechanical working life | |
| - mating cycles | ≥ 500 |

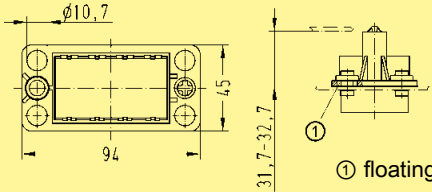

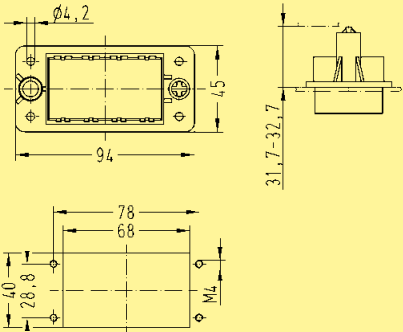

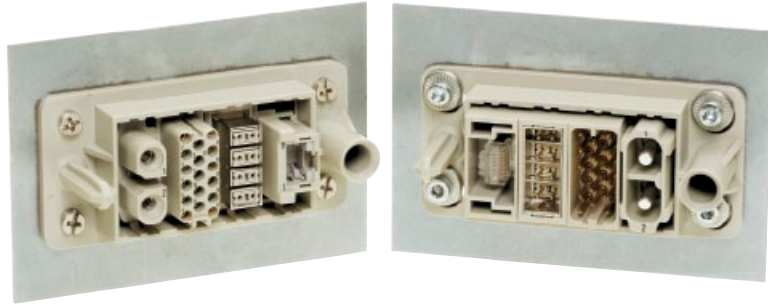

| Identification | Part number | | Drawing | Dimensions in mm |
|--|-------------------------------|-------------------------------|--|--|
| | Marking A ... F ¹⁾ | Marking a ... f ²⁾ | | |
| Docking frame for 2 modules  | 09 14 006 1701 | |  | ① floating tolerance ± 2 mm Panel cut out |
| Docking frame for 2 modules  | | 09 14 006 1711 |  | Panel cut out |
| Docking frame for 4 modules  | 09 14 016 1701 | |  | ① floating tolerance ± 2 mm |
| Docking frame for 4 modules  | | 09 14 016 1711 |  | Panel cut out |

1) Float mount
2) Fixed

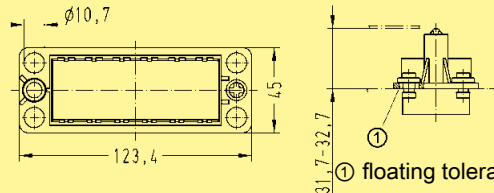

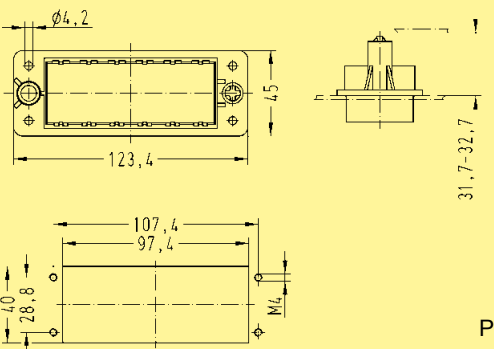
Han
Modular

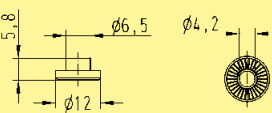
| Identification | Part number | | Drawing | Dimensions in mm |
|---|-------------------------------|-------------------------------|--|------------------|
| | Marking A ... F ¹⁾ | Marking a ... f ²⁾ | | |
| Docking frame for 6 modules  | 09 14 024 1701 | |  <p>① floating tolerance ± 2 mm</p> | |
| Docking frame for 6 modules  | | 09 14 024 1711 |  <p>Panel cut out</p> | |
| Float washer to enable the frame to be float mounted using standard M4 fixing screws  | 09 14 000 9936 | |  | |

1) Float mount
2) Fixed

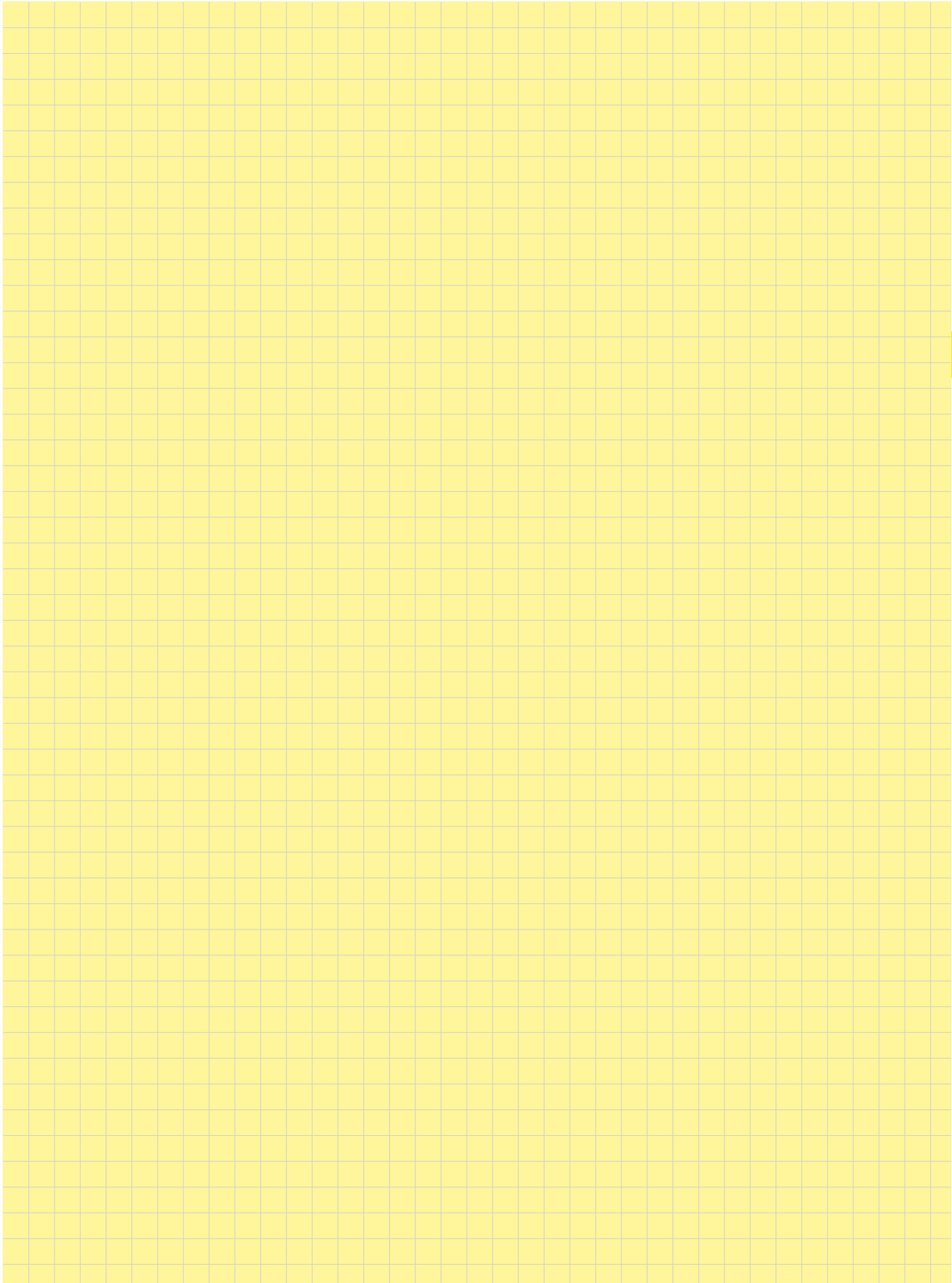

Features

- Suitable for all Han-Modular® single modules
- The variant with PE connection uses pin 1 of the module as PE
- Slim, space saving design
- Low cost plastic hoods and housings

Technical characteristics





| | |
|----------------|----------------------------------|
| Specifications | DIN EN 60 664-1 DIN EN 61 984 |
|----------------|----------------------------------|

Hoods/Housings

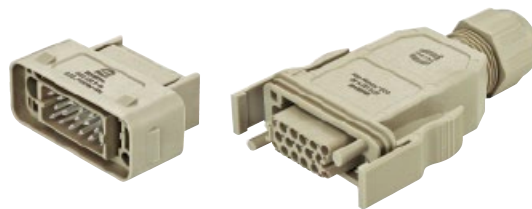
| | |
|---|-------------------|
| Material | |
| - Hoods/Housings | polycarbonate |
| - Seal | NBR |
| - Cable seal | Polyamide |
| Limiting temperatures | -40 °C ... +85 °C |
| Flammability acc. to UL 94 | V 0 |
| Degree of protection acc. to DIN EN 60 529 for coupled connector | IP 20 / IP 65 |
| Mechanical working life | |
| - mating cycles | ≥ 500 |

Plastic hoods/housings
with PE marking







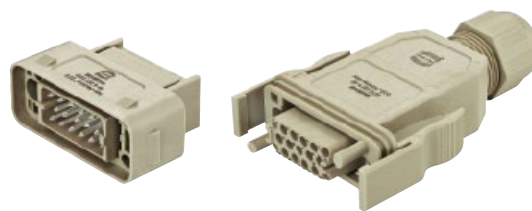

| Identification | Part number | Drawing | Dimensions in mm |
|--|-----------------------|--|--|
| Hoods with PE marking (pin 1 = PE) IP 65 top entry  | 09 14 001 0421 | | |
| Hoods with PE marking (pin 1 = PE) IP 20 top entry  | 09 14 001 0423 | | |
| Housing, bulkhead mounting with PE marking (pin 1 = PE) IP 20 / IP 65  | 09 14 001 0321 | | Panel cut out |
| Coding pin  | 09 14 000 9929 |  | Range of delivery: 8 pieces per frame |

Han
Modular

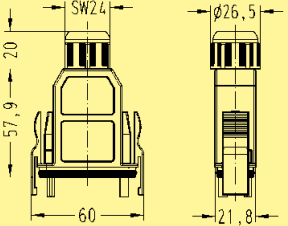
Plastic hoods/housings
without PE

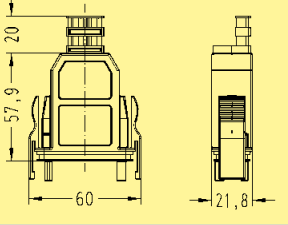

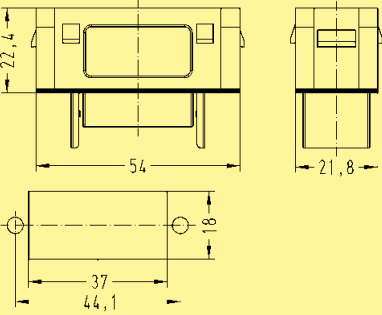
Han
Modular

| Identification | Part number | Drawing | Dimensions in mm |
|---|-----------------------|--|--|
| Hoods without PE IP 65 top entry  | 09 14 001 0420 |  | |
| Hoods without PE IP 20 top entry  | 09 14 001 0422 |  | |
| Housing, bulkhead mounting without PE IP 20 / IP 65  | 09 14 001 0320 |  | Panel cut out |
| Coding pin  | 09 14 000 9929 |  | Range of delivery: 8 pieces per frame |

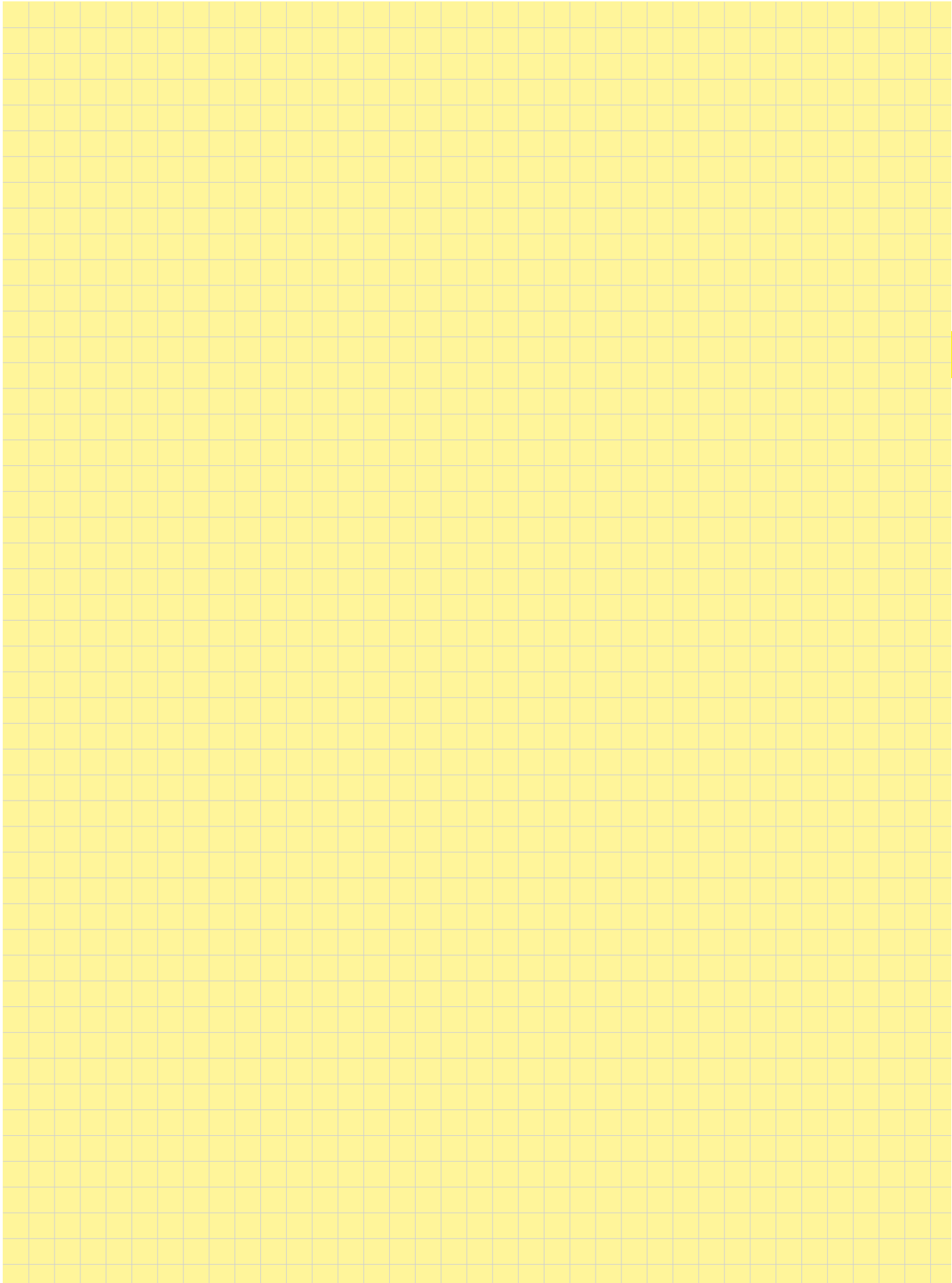

Features

- Axial-screw termination
- No special tools required
- Power module for big wire gauge up to 70 mm²
- Suitable as a 3 + PE connector in a Han® 32 B housing
- Compatible to the Han® 200 A module with crimp terminal

Han Modular

Technical characteristics

Specifications DIN EN 60 664-1
DIN EN 61 984

Approvals

Inserts

Number of contacts 1
Electrical data acc. to EN 61 984 **200 A 1000 V 8 kV 3**
Rated current 200 A
Rated voltage 1000 V
Rated impulse voltage 8 kV
Pollution degree 3

Rated voltage acc. to UL 600 V
Insulation resistance $\geq 10^{10} \Omega$
Material polycarbonate
Limiting temperatures -40 °C ... +125 °C
Flammability acc. to UL 94 V 0
Mechanical working life - mating cycles ≥ 500

Contacts

Material copper alloy
Surface - hard-silver plated 3 μm Ag
Contact resistance 0.2 m Ω
Screw terminal
- Wire gauge ¹⁾ 25 ... 70 mm²
- AWG 2 ... 00
- Hexagonal driver SW 5
- Stripping length 16 mm
- Tightening torque

| | | | | |
|-----------------|----|----|----|----|
| mm ² | 25 | 35 | 50 | 70 |
| Nm | 8 | 8 | 9 | 10 |

Current carrying capacity

The current carrying capacity of the connectors is limited by the thermal load capability of the contact element material including the connections and the insulating parts. The derating curve is therefore valid for currents which flow constantly (non-intermittent) through each contact element of the connector evenly, without exceeding the allowed maximum temperature.

Measuring and testing techniques according to DIN EN 60 512-5

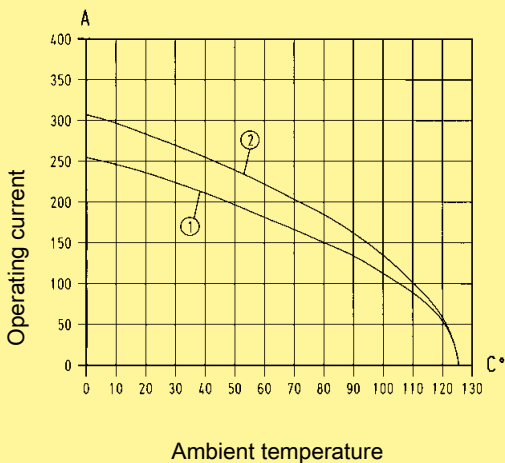

① 24 B hoods/housings with 3 modules; wire gauge: 50 mm²

② 24 B hoods/housings with 3 modules; wire gauge: 70 mm²

Number of contacts

1

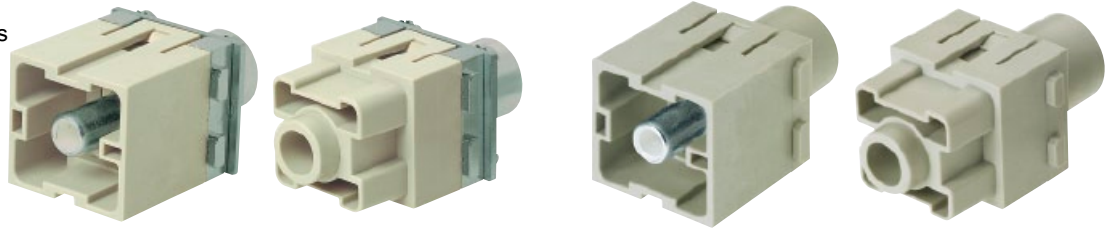

| Identification | Part number | | Drawing | Dimensions in mm |
|---|-----------------------|-----------------------|---------|------------------|
| | Male insert (M) | Female insert (F) | | |
| Axial screw terminal 200 A | | | | |
| 25 ... 40 mm ² | 09 14 001 2663 | 09 14 001 2763 | | |
| 40 ... 70 mm ² | 09 14 001 2662 | 09 14 001 2762 | | |
| Axial screw terminal 200 A PE (Ground) | | | | |
| 25 ... 40 mm ² | 09 14 001 2668 | 09 14 001 2768 | | |
| 40 ... 70 mm ² | 09 14 001 2667 | 09 14 001 2767 | | |
| | | | | |

Han
Modular

| Identification | Part number | Drawing | Dimensions in mm |
|------------------------------------|-----------------------|---------|------------------|
| Hex key SW 5 for axial setscrew | | | |
| with grip | 09 99 000 0364 | | |
| adapter 3/8" | 09 99 000 0371 | | |



Features

- Crimp termination
- Contacts can be unlocked from the mating side
- Compatible with Han® 200 A modules with axial screw terminal

Technical characteristics

| | |
|----------------|---|
| Specifications | EN 50 124-1 DIN EN 60 664-1 DIN EN 61 984 |
|----------------|---|

Inserts

| | |
|--|----------------------------|
| Number of contacts | 1 |
| Electrical data acc. to EN 61 984 | 200 A 1000 V 8 kV 3 |
| Rated current | 200 A |
| Rated voltage | 1000 V |
| Rated impulse voltage | 8 kV |
| Pollution degree | 3 |
| Insulation resistance | $\geq 10^{10} \Omega$ |
| Material | polycarbonate |
| Limiting temperatures | -40 °C ... +125 °C |
| Flammability acc. to UL 94 | V 0 |
| Mechanical working life - mating cycles | ≥ 500 |

Contacts

| | |
|--------------------------|----------------------------|
| Material | copper alloy |
| Surface | |
| - hard-silver plated | 3 μm Ag |
| Contact resistance | $\leq 0.3 \text{ m}\Omega$ |
| Crimp terminal | |
| - mm^2 | 25 ... 70 mm^2 |
| Max. insulation diameter | 18 mm |

Current carrying capacity

The current carrying capacity of the connectors is limited by the thermal load capability of the contact element material including the connections and the insulating parts. The derating curve is therefore valid for currents which flow constantly (non-intermittent) through each contact element of the connector evenly, without exceeding the allowed maximum temperature.

Measuring and testing techniques according to DIN EN 60 512-5

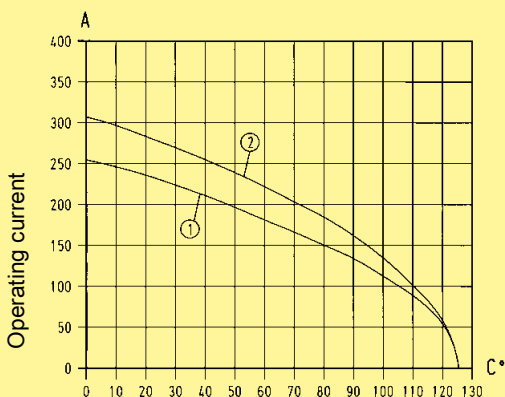

Ambient temperature

- ① 24 B hoods/housings with 3 modules; wire gauge: 50 mm^2
 ② 24 B hoods/housings with 3 modules; wire gauge: 70 mm^2

Number of contacts

1

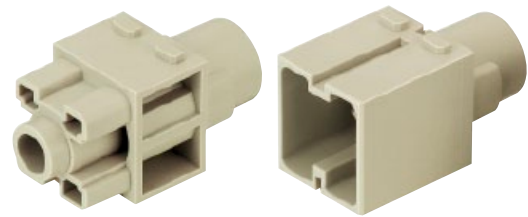

| Identification | Part number | | Drawing | Dimensions in mm |
|----------------------|-----------------------|-----------------------|---------|------------------|
| | Male insert (M) | Female insert (F) | | |
| Crimp terminal Modul | 09 14 001 3001 | 09 14 001 3101 | | |

Han Modular

| Identification | Wire gauge (mm ²) | Part number | | Drawing | Dimensions in mm |
|----------------------------------|-------------------------------|-----------------------|-----------------------|---------|------------------|
| | | Male contact | Female contact | | |
| Crimp contacts* silver plated | | | | | |
| | 25 | 09 11 000 6120 | 09 11 000 6220 | | |
| | 35 | 09 11 000 6121 | 09 11 000 6221 | | |
| | 50 | 09 11 000 6122 | 09 11 000 6222 | | |
| | 70 | 09 11 000 6123 | 09 11 000 6223 | | |

| Wire gauge | ∅ | Stripping length A |
|--------------------|------|--------------------|
| 25 mm ² | 7 | 19 mm |
| 35 mm ² | 8.2 | 20 mm |
| 50 mm ² | 10 | 22.5 mm |
| 70 mm ² | 11.5 | 22.5 mm |

for stranded wire according to IEC 60 228 Class 5

* Crimp zone acc. to DIN EN 46 235

Features

- Axial-screw termination
- No special tools required
- Connect PE contact with special cable shoe
- Compatible to the Han® 100 A module with crimp terminal

Technical characteristics

Specifications DIN EN 60 664-1
DIN EN 61 984

Approvals

Inserts

Number of contacts 2
 Electrical data
 acc. to EN 61 984 **100 A 1000 V 8 kV 3**
 Rated current 100 A
 Rated voltage 1000 V
 Rated impulse voltage 8 kV
 Pollution degree 3

Rated voltage
 acc. to UL 600 V
 Insulation resistance ≥ 10¹⁰ Ω
 Material polycarbonate
 Limiting temperatures -40 °C ... +125 °C
 Flammability acc. to UL 94 V 0
 Mechanical working life
 - mating cycles ≥ 500

Contacts

Material copper alloy
 Surface
 - hard-silver plated 3 μm Ag
 Contact resistance 0.3 mΩ
 Screw terminal
 - Wire gauge ¹⁾ 10 ... 38 mm²
 - AWG 6 ... 2
 - Hexagonal driver SW 4
 - Stripping length 13 mm
 - Tightening torque

| | | | | |
|-----------------|----|----|----|----|
| mm ² | 10 | 16 | 25 | 35 |
| Nm | 6 | 6 | 7 | 8 |

Current carrying capacity

The current carrying capacity of the connectors is limited by the thermal load capability of the contact element material including the connections and the insulating parts. The derating curve is therefore valid for currents which flow constantly (non-intermittent) through each contact element of the connector evenly, without exceeding the allowed maximum temperature.

Measuring and testing techniques according to DIN EN 60 512-5

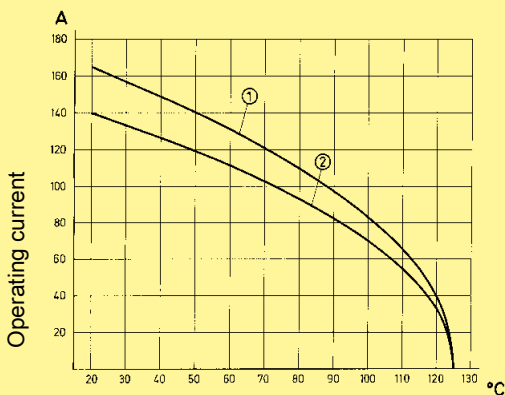

Ambient temperature

① 24 B hoods/housings with 3 modules; wire gauge: 35 mm²

② 24 B hoods/housings with 3 modules; wire gauge: 25 mm²

Number of contacts

2

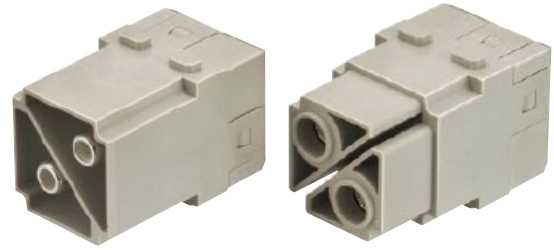

| Identification | Part number | | Drawing | Dimensions in mm |
|-------------------------------|-----------------------|-----------------------|---------|------------------|
| | Male insert (M) | Female insert (F) | | |
| Axial screw terminal 100 A | | | | |
| 10 ... 25 mm ² | 09 14 002 2653 | 09 14 002 2753 | | |
| 16 ... 35 mm ² | 09 14 002 2651 | 09 14 002 2751 | | |
| 38 mm ² | 09 14 002 2650 | 09 14 002 2750 | | |

Han
Modular

| Identification | Part number | Drawing | Dimensions in mm |
|---|-----------------------|---------|---|
| Hex key SW 4 for axial setscrew | | | |
| with grip | 09 99 000 0363 | | |
| adapter 3/8" | 09 99 000 0370 | | |
| Cable shoe 16 mm ² for PE extension | | | |
| Comment for hoods/ housings high construction only | 09 14 000 9912 | | Please use pressing tools for non-insulated cable shoes fol- lowing DIN 46 230 with 16 mm ² range (eg. K25, co. Klauke) |

06
29

Stock items in bold type

Features

- Crimp termination
- Unlock of contacts from mating side
- Connect PE contact with special cable shoe
- Compatible to Han® 100 A module with axial screw terminal

Technical characteristics

Specifications DIN EN 60 664-1
 DIN EN 61 984

Approvals

Inserts

Number of contacts 2
 Electrical data
 acc. to EN 61 984 **100 A 1000 V 8 kV 3**
 Rated current 100 A
 Rated voltage 1000 V
 Rated impulse voltage 8 kV
 Pollution degree 3

Rated voltage
 acc. to UL 600 V
 Insulation resistance $\geq 10^{10} \Omega$
 Material polycarbonate
 Limiting temperatures -40 °C ... +125 °C
 Flammability acc. to UL 94 V 0
 Mechanical working life
 - mating cycles ≥ 500

Contacts

Material copper alloy
 Surface
 - hard-silver plated 3 μm Ag
 Contact resistance $\leq 0.3 \text{ m}\Omega$
 Crimp terminal
 - mm² 10 ... 35 mm²
 Max. cable diameter 14 mm

Crimp zone (C)

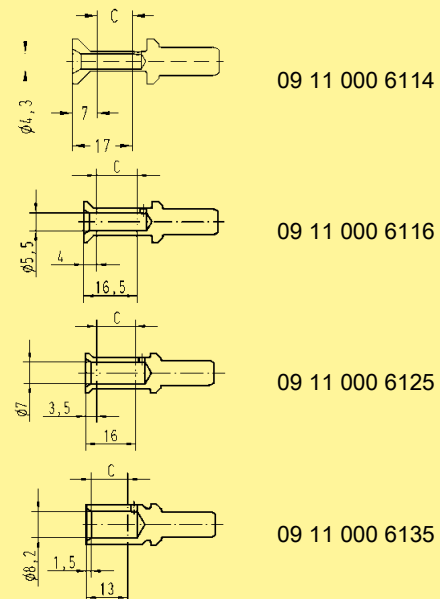

Current carrying capacity

The current carrying capacity of the connectors is limited by the thermal load capability of the contact element material including the connections and the insulating parts. The derating curve is therefore valid for currents which flow constantly (non-intermittent) through each contact element of the connector evenly, without exceeding the allowed maximum temperature.

Measuring and testing techniques according to DIN EN 60 512-5

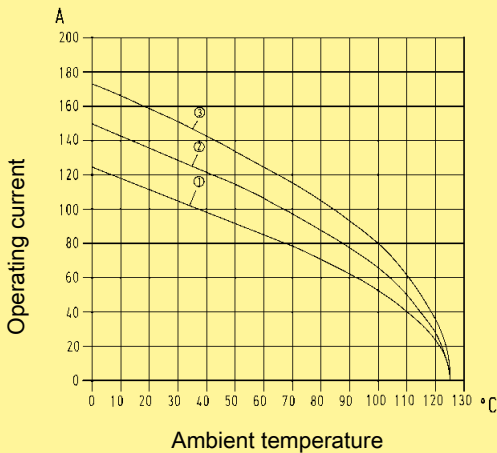

- ① 24 B hoods/housings with 3 modules; wire gauge: 16 mm²
- ② 24 B hoods/housings with 3 modules; wire gauge: 25 mm²
- ③ 24 B hoods/housings with 3 modules; wire gauge: 35 mm²

Number of contacts

2

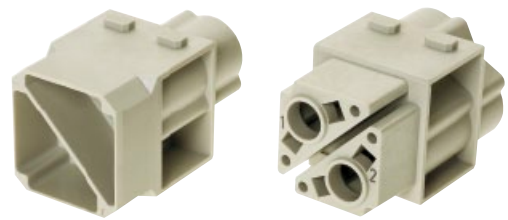

| Identification | Part number | | Drawing | Dimensions in mm |
|------------------------------|-----------------------|-----------------------|---------|------------------|
| | Male insert (M) | Female insert (F) | | |
| Crimp terminal Modul | 09 14 002 3051 | 09 14 002 3151 | | |
| Removal tool for TC contacts | 09 99 000 0383 | 09 99 000 0383 | | |

Han Modular

| Identification | Wire gauge (mm ²) | Part number | | Drawing | Dimensions in mm |
|-------------------------------|-------------------------------|-----------------------|-----------------------|---------|------------------|
| | | Male contact | Female contact | | |
| Crimp contacts* silver plated | | | | | |
| | 10 | 09 11 000 6114 | 09 11 000 6214 | | |
| | 16 | 09 11 000 6116 | 09 11 000 6216 | | |
| | 25 | 09 11 000 6125 | 09 11 000 6225 | | |
| | 35 | 09 11 000 6135 | 09 11 000 6235 | | |

| Wire gauge | Ø | Stripping length (A) |
|--------------------|-----|----------------------|
| 10 mm ² | 4.3 | 19 mm |
| 16 mm ² | 5.5 | 19 mm |
| 25 mm ² | 7.0 | 19 mm |
| 35 mm ² | 8.2 | 16 mm |

for stranded wire acc. to IEC 60 228 Class 5

* Crimp zone acc. to DIN EN 46 235

Features

- Crimp or axial screw termination available
- Unlock of contacts with a screw driver from mating side
- Connect PE contact with special cable shoe (see chapter 40 in the main catalogue „Industrial Connectors Han®)
- Separate axial screw contacts can be terminated without any special tools directly to the wire.

Technical characteristics

Specifications DIN EN 60 664-1
DIN EN 61 984

Inserts

Number of contacts 1
 Electrical data acc. to EN 61 984 **100 A 830 V 8 kV 3**
 Rated current 100 A
 Rated voltage 830 V
 Rated impulse voltage 8 kV
 Pollution degree 3

Insulation resistance ≥ 10¹⁰ Ω
 Material polycarbonate
 Limiting temperatures -40 °C ... +125 °C
 Flammability acc. to UL 94 V 0
 Mechanical working life
 - mating cycles ≥ 500
 Max. insulation diameter 13 mm

Crimp Contacts

Material copper alloy
 Surface
 - hard-silver plated 3 μm Ag
 Contact resistance ≤ 0.3 mΩ
 Crimp terminal
 - wire gauge 10 ... 35 mm²

Axial Screw Contacts

Material copper alloy
 Surface
 - hard-silver plated 3 μm Ag
 Contact resistance ≤ 0.3 mΩ
 Screw terminal
 - wire gauge¹⁾ 10 ... 35 mm²
 - AWG 6 ... 2
 - hexagonal driver SW 4
 - tightening torque

| | | | | |
|-----------------|----|----|----|----|
| mm ² | 10 | 16 | 25 | 35 |
| Nm | 6 | 6 | 7 | 8 |

Number of contacts

1

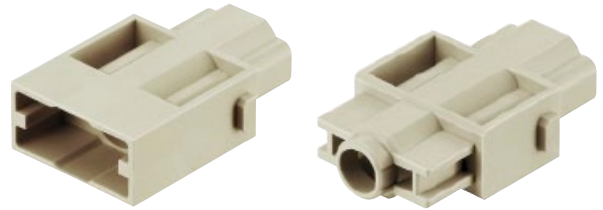

| Identification | Part number | | Drawing | Dimensions in mm |
|---|-----------------------|-----------------------|------------------------------|------------------|
| | Male insert (M) | Female insert (F) | | |
| 100 A single module order contacts separately | 09 14 001 3031 | 09 14 001 3131 | <p>view termination side</p> | |

Han
Modular

| Identification | Wire gauge (mm ²) | Part number | | Drawing | Dimensions in mm | | | | | | | | | | | | | | | |
|---|----------------------------------|--|--|-------------------------------|---|------------|---|----------------------|--------------------|-----|-------|--------------------|-----|-------|--------------------|-----|-------|--------------------|-----|-------|
| | | Male contact | Female contact | | | | | | | | | | | | | | | | | |
| Contacts axial screw terminal | 10-25 16-35 | 09 11 000 6112 09 11 000 6113 | 09 11 000 6212 09 11 000 6213 | <p>Stripping length 13 mm</p> | | | | | | | | | | | | | | | | |
| crimp terminal* | 10 16 25 35 | 09 11 000 6114 09 11 000 6116 09 11 000 6125 09 11 000 6135 | 09 11 000 6214 09 11 000 6216 09 11 000 6225 09 11 000 6235 | | <table border="1"> <thead> <tr> <th>Wire gauge</th> <th>Ø</th> <th>Stripping length (A)</th> </tr> </thead> <tbody> <tr> <td>10 mm²</td> <td>4.3</td> <td>19 mm</td> </tr> <tr> <td>16 mm²</td> <td>5.5</td> <td>19 mm</td> </tr> <tr> <td>25 mm²</td> <td>7.0</td> <td>19 mm</td> </tr> <tr> <td>35 mm²</td> <td>8.2</td> <td>16 mm</td> </tr> </tbody> </table> <p>for stranded wire acc. to IEC 60 228 Class 5</p> | Wire gauge | Ø | Stripping length (A) | 10 mm ² | 4.3 | 19 mm | 16 mm ² | 5.5 | 19 mm | 25 mm ² | 7.0 | 19 mm | 35 mm ² | 8.2 | 16 mm |
| Wire gauge | Ø | Stripping length (A) | | | | | | | | | | | | | | | | | | |
| 10 mm ² | 4.3 | 19 mm | | | | | | | | | | | | | | | | | | |
| 16 mm ² | 5.5 | 19 mm | | | | | | | | | | | | | | | | | | |
| 25 mm ² | 7.0 | 19 mm | | | | | | | | | | | | | | | | | | |
| 35 mm ² | 8.2 | 16 mm | | | | | | | | | | | | | | | | | | |

* Crimp zone acc. to DIN EN 46 235

Features

- Axial-screw termination
- 2 contacts (70 A) for power circuits
- Male inserts with protection collar
- Male and female contacts are finger safe
- Compatible to Han® 70 A module with crimp terminal

Technical characteristics

Specifications DIN EN 60 664-1
 DIN EN 61 984

Approvals

Inserts

Number of contacts 2
 Electrical data
 acc. to EN 61 984 **70 A 1000 V 8 kV 3**
 Rated current 70 A
 Rated voltage 1000 V
 Rated impulse voltage 8 kV
 Pollution degree 3

Rated voltage
 acc. to UL 600 V
 Insulation resistance $\geq 10^{10} \Omega$
 Material polycarbonate
 Limiting temperatures -40 °C ... +125 °C
 Flammability acc. to UL 94 V 0
 Mechanical working life
 - mating cycles ≥ 500

Contacts

Material copper alloy
 Surface
 - hard-silver plated 3 μm Ag
 Contact resistance 0.5 m Ω
 Screw terminal
 - Wire gauge ¹⁾ 6 ... 22 mm²
 - AWG 8 ... 4
 - Hexagonal driver SW 2.5
 - Stripping length

| | | | | |
|-----------------|------------------|------------------|------------------|--------------------|
| mm ² | 6 | 10 | 16 | 22 |
| mm | 11 ⁺¹ | 11 ⁺¹ | 11 ⁺¹ | 12.5 ⁺¹ |

- Tightening torque

| | | | | |
|-----------------|---|----|----|----|
| mm ² | 6 | 10 | 16 | 22 |
| Nm | 2 | 3 | 4 | 5 |

Current carrying capacity

The current carrying capacity of the connectors is limited by the thermal load capability of the contact element material including the connections and the insulating parts. The derating curve is therefore valid for currents which flow constantly (non-intermittent) through each contact element of the connector evenly, without exceeding the allowed maximum temperature.

Measuring and testing techniques according to DIN EN 60 512-5

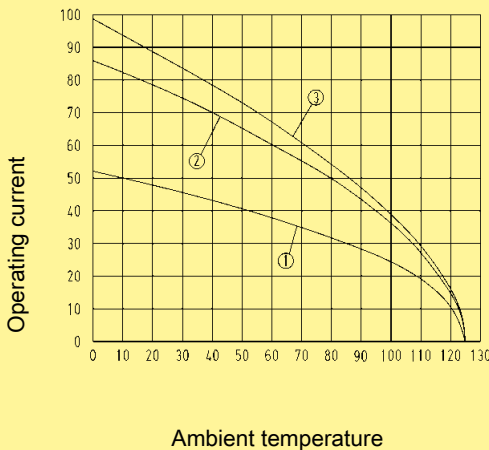

- ① 24 B hoods/housings with 6 modules; wire gauge: 6 mm²
- ② 24 B hoods/housings with 6 modules; wire gauge: 16 mm²
- ③ 24 B hoods/housings with 6 modules; wire gauge: 22 mm²

1) geometric wire gauge

Number of contacts

2

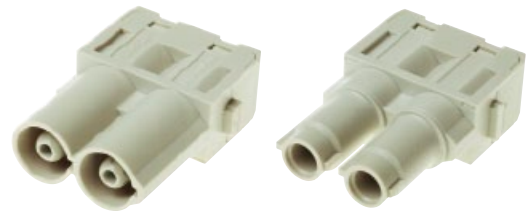

| Identification | Part number | | Drawing | Dimensions in mm |
|--|-----------------------|-----------------------|---------|------------------|
| | Male insert (M) | Female insert (F) | | |
| Axial screw terminal 70 A | | | | |
| 6 ... 16 mm ² | 09 14 002 2646 | 09 14 002 2741 | | |
| 14 ... 22 mm ² | 09 14 002 2647 | 09 14 002 2742 | | |
| Axial screw terminal 70 A with finger protected male contacts | | | | |
| 6 ... 16 mm ² | 09 14 002 2641 | | | |
| 14 ... 22 mm ² | 09 14 002 2642 | | | |

Han
Modular

| Identification | Part number | Drawing | Dimensions in mm |
|--------------------------------------|-----------------------|---------|------------------|
| Hex key SW 2.5 for axial setscrew | | | |
| Bit 1/4" | 09 99 000 0375 | | |
| | | | |

Features

- Crimp termination
- Compatible with Han® 70 A module with axial screw termination
- Contacts are removed without tools

Technical characteristics

| | |
|----------------|----------------------------------|
| Specifications | DIN EN 60 664-1 DIN EN 61 984 |
|----------------|----------------------------------|

Inserts

| | |
|--|---------------------------|
| Number of contacts | 2 |
| Electrical data acc. to DIN EN 61 984 | 70 A 1000 V 8 kV 3 |
| Rated current | 70 A |
| Rated voltage | 1000 V |
| Rated impulse voltage | 8 kV |
| Pollution degree | 3 |
| Insulation resistance | $\geq 10^{10} \Omega$ |
| Material | Polycarbonate |
| Limiting temperatures | -40 °C ... +125 °C |
| Flammability acc. to UL 94 | V 0 |
| Mechanical working life | ≥ 500 mating cycles |

Contacts

| | |
|--------------------------|----------------------------|
| Power contacts | |
| Material | Copper alloy |
| Surface | |
| - hard-silver plated | 3 μm Ag |
| Contact resistance | $\leq 0.5 \text{ m}\Omega$ |
| Crimp terminal | |
| - wire gauge | 10 - 25 mm ² |
| Max. insulation diameter | 11 mm |
| Stripping length | 15.5 mm |

Number of contacts

2



| Identification | Part-Number | | Drawings | Dimensions in mm |
|------------------------------------|-----------------|-------------------|----------|------------------|
| | Male insert (M) | Female insert (F) | | |
| Han® 70 A module Crimp terminal | 09 14 002 3041 | 09 14 002 3141 | | |

Han Modular

| Identification | Wire gauge mm ² | Part-Number | | Drawings | Dimensions in mm | | | | | | | | | | | | |
|----------------------------------|-------------------------------|--|--|----------|--|------------|---|------------------|--------------------|-----|---------|--------------------|-----|---------|--------------------|-----|---------|
| | | Male contacts (M) | Female contacts (F) | | | | | | | | | | | | | | |
| Crimp contacts* Silver plated | 10 16 25 | 09 11 000 6131 09 11 000 6132 09 11 000 6133 | 09 11 000 6231 09 11 000 6232 09 11 000 6233 | | <table border="1"> <thead> <tr> <th>Wire gauge</th> <th>Ø</th> <th>Stripping length</th> </tr> </thead> <tbody> <tr> <td>10 mm²</td> <td>4.3</td> <td>15.5 mm</td> </tr> <tr> <td>16 mm²</td> <td>5.5</td> <td>15.5 mm</td> </tr> <tr> <td>25 mm²</td> <td>7.0</td> <td>15.5 mm</td> </tr> </tbody> </table> <p>for stranded wires acc. to IEC 60 228 class 5</p> | Wire gauge | Ø | Stripping length | 10 mm ² | 4.3 | 15.5 mm | 16 mm ² | 5.5 | 15.5 mm | 25 mm ² | 7.0 | 15.5 mm |
| Wire gauge | Ø | Stripping length | | | | | | | | | | | | | | | |
| 10 mm ² | 4.3 | 15.5 mm | | | | | | | | | | | | | | | |
| 16 mm ² | 5.5 | 15.5 mm | | | | | | | | | | | | | | | |
| 25 mm ² | 7.0 | 15.5 mm | | | | | | | | | | | | | | | |

* Crimp zone acc. to DIN EN 46 235

Features

- Axial-screw termination
- No special tools required
- Compatible to Han® 40 A module with crimp terminal

Technical characteristics

Specifications DIN EN 60 664-1
DIN EN 61 984

Approvals

Inserts

Number of contacts 2
 Electrical data
 acc. to EN 61 984 **40 A 1000 V 8 kV 3**
 Rated current 40 A
 Rated voltage 1000 V
 Rated impulse voltage 8 kV
 Pollution degree 3

Rated voltage
 acc. to UL 600 V
 Insulation resistance ≥ 10¹⁰ Ω
 Material polycarbonate
 Limiting temperatures -40 °C ... +125 °C
 Flammability acc. to UL 94 V 0
 Mechanical working life
 - mating cycles ≥ 500

Contacts

Material copper alloy

Surface
 - hard-silver plated 3 μm Ag

Contact resistance 0.5 mΩ

Screw terminal 2.5 ... 10 mm²

- Wire gauge ¹⁾ 14 ... 8

- AWG SW 2

- Hexagonal driver

- Stripping length

| | | | | |
|-----------------|-----------------|-----------------|-----------------|------------------|
| mm ² | 2.5 | 4 | 6 | 10 |
| mm | 5 ⁺¹ | 5 ⁺¹ | 8 ⁺¹ | 11 ⁺¹ |

- Tightening torque

| | | | | |
|-----------------|-----|-----|---|----|
| mm ² | 2.5 | 4 | 6 | 10 |
| Nm | 1.5 | 1.5 | 2 | 2 |

Current carrying capacity

The current carrying capacity of the connectors is limited by the thermal load capability of the contact element material including the connections and the insulating parts. The derating curve is therefore valid for currents which flow constantly (non-intermittent) through each contact element of the connector evenly, without exceeding the allowed maximum temperature.

Measuring and testing techniques according to DIN EN 60 512-5

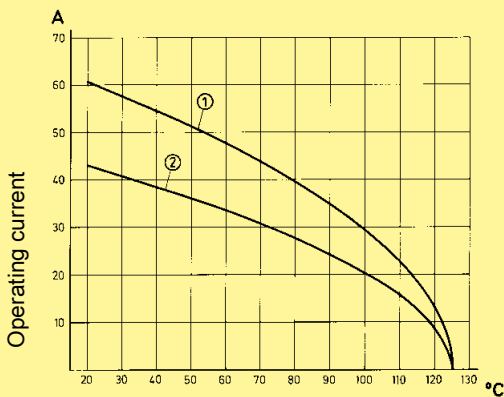

Ambient temperature

① 24 B hoods/housings with 6 modules; wire gauge: 10 mm²

② 24 B hoods/housings with 6 modules; wire gauge: 6 mm²

Number of contacts

2

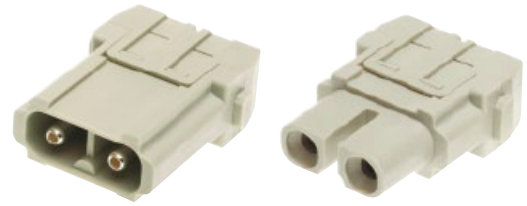

| Identification | Part number | | Drawing | Dimensions in mm |
|------------------------------|-----------------------|-----------------------|---|------------------|
| | Male insert (M) | Female insert (F) | | |
| Axial screw terminal 40 A | | | <p>M</p> <p>F</p> <p>Contact arrangement view from termination side</p> | |
| 2.5 ... 8 mm ² | 09 14 002 2601 | 09 14 002 2701 | | |
| 6 ... 10 mm ² | 09 14 002 2602 | 09 14 002 2702 | | |

Han
Modular

| Identification | Part number | Drawing | Dimensions in mm |
|------------------------------------|-----------------------|---------|------------------|
| Hex key SW 2 for axial setscrew | | | |
| with grip | 09 99 000 0313 | | |
| Bit 1/4" | 09 99 000 0369 | | |

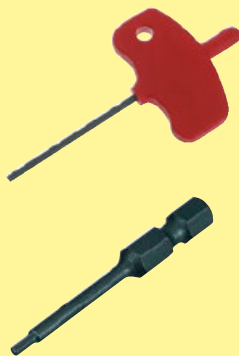

Features

- Crimp termination
- Compatible with Han[®] 40 A module with axial screw terminal

Han
Modular

Current carrying capacity

The current carrying capacity of the connectors is limited by the thermal load capability of the contact element material including the connections and the insulating parts. The derating curve is therefore valid for currents which flow constantly (non-intermittent) through each contact element of the connector evenly, without exceeding the allowed maximum temperature.

Measuring and testing techniques according to DIN EN 60 512-5

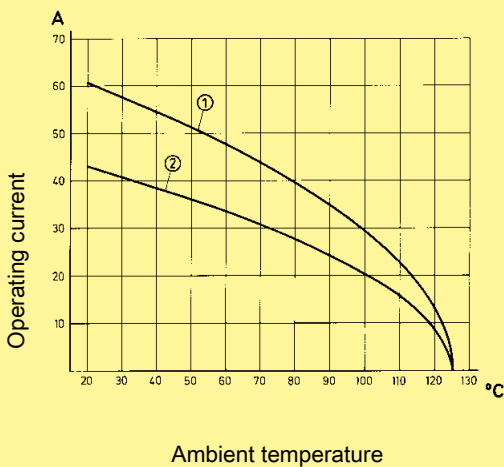

① 24 B hoods/housings with 6 modules; wire gauge: 10 mm²

② 24 B hoods/housings with 6 modules; wire gauge: 6 mm²

Technical characteristics

Specifications DIN EN 60 664-1
 DIN EN 61 984

Approvals

Inserts

| | |
|----------------------------|---------------------------|
| Number of contacts | 2 |
| Electrical data | |
| acc. to EN 61 984 | 40 A 1000 V 8 kV 3 |
| Rated current | 40 A |
| Rated voltage | 1000 V |
| Rated impulse voltage | 8 kV |
| Pollution degree | 3 |
| Rated voltage | |
| acc. to UL | 600 V |
| Insulation resistance | ≥ 10 ¹⁰ Ω |
| Material | polycarbonate |
| Limiting temperatures | -40 °C ... +125 °C |
| Flammability acc. to UL 94 | V 0 |
| Mechanical working life | |
| - mating cycles | |

Contacts

| | |
|----------------------|----------------------------|
| Material | copper alloy |
| Surface | |
| - hard-silver plated | 3 µm Ag |
| Contact resistance | ≤ 0.3 mΩ |
| Crimp terminal | |
| - mm ² | 1.5 ... 10 mm ² |
| - AWG | 16 ... 8 |

Number of contacts

2

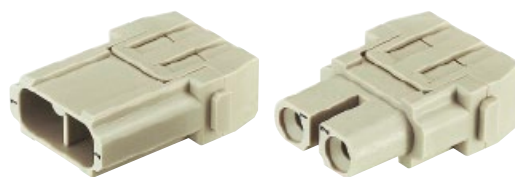

| Identification | Part number | | Drawing | Dimensions in mm |
|---|-----------------------|-----------------------|---|------------------|
| | Male insert (M) | Female insert (F) | | |
| Crimp terminal Order crimp contacts separately | 09 14 002 3002 | 09 14 002 3102 | <p>Contact arrangement view from termination side</p> | |

Han Modular

| Identification | Wire gauge (mm ²) | Part number | | Drawing | Dimensions in mm | | | | | | | | | | | | | | | | | | | | | | | | | | | | | | |
|---|-------------------------------|---|---|------------------|--|------------|--|--|---|------------------|-----|-----------------|--------|------|------|-----|-----------------|--------|------|------|---|-----------------|--------|------|--------|---|-----------------|--------|-----|--------|----|-----------------|-------|-----|-------|
| | | Male contact | Female contact | | | | | | | | | | | | | | | | | | | | | | | | | | | | | | | | |
| Crimp contacts Power contacts silver plated | | | | | | | | | | | | | | | | | | | | | | | | | | | | | | | | | | | |
| | 1.5 2.5 4 6 10 | 09 32 000 6104 09 32 000 6105 09 32 000 6107 09 32 000 6108 09 32 000 6109 | 09 32 000 6204 09 32 000 6205 09 32 000 6207 09 32 000 6208 09 32 000 6209 | | <table border="1"> <thead> <tr> <th colspan="3">Wire gauge</th> <th>∅</th> <th>Stripping length</th> </tr> </thead> <tbody> <tr> <td>1.5</td> <td>mm²</td> <td>AWG 16</td> <td>1.75</td> <td>9 mm</td> </tr> <tr> <td>2.5</td> <td>mm²</td> <td>AWG 14</td> <td>2.25</td> <td>9 mm</td> </tr> <tr> <td>4</td> <td>mm²</td> <td>AWG 12</td> <td>2.85</td> <td>9.6 mm</td> </tr> <tr> <td>6</td> <td>mm²</td> <td>AWG 10</td> <td>3.5</td> <td>9.6 mm</td> </tr> <tr> <td>10</td> <td>mm²</td> <td>AWG 8</td> <td>4.3</td> <td>15 mm</td> </tr> </tbody> </table> <p>Stripping length a = 15 mm for cables ≥ 5 mm Stripping length a = 18 mm for cables ≥ 6.4 mm</p> | Wire gauge | | | ∅ | Stripping length | 1.5 | mm ² | AWG 16 | 1.75 | 9 mm | 2.5 | mm ² | AWG 14 | 2.25 | 9 mm | 4 | mm ² | AWG 12 | 2.85 | 9.6 mm | 6 | mm ² | AWG 10 | 3.5 | 9.6 mm | 10 | mm ² | AWG 8 | 4.3 | 15 mm |
| Wire gauge | | | ∅ | Stripping length | | | | | | | | | | | | | | | | | | | | | | | | | | | | | | | |
| 1.5 | mm ² | AWG 16 | 1.75 | 9 mm | | | | | | | | | | | | | | | | | | | | | | | | | | | | | | | |
| 2.5 | mm ² | AWG 14 | 2.25 | 9 mm | | | | | | | | | | | | | | | | | | | | | | | | | | | | | | | |
| 4 | mm ² | AWG 12 | 2.85 | 9.6 mm | | | | | | | | | | | | | | | | | | | | | | | | | | | | | | | |
| 6 | mm ² | AWG 10 | 3.5 | 9.6 mm | | | | | | | | | | | | | | | | | | | | | | | | | | | | | | | |
| 10 | mm ² | AWG 8 | 4.3 | 15 mm | | | | | | | | | | | | | | | | | | | | | | | | | | | | | | | |

Features

- Axial screw terminal
- No special tools required for assembly
- Compatible to Han® C module with crimp terminal

Technical characteristics

Specifications DIN EN 60 664-1
DIN EN 61 984

Approvals

Inserts

Number of contacts 3
 Electrical data
 acc. to EN 61 984 **40 A 690 V 8 kV 3**
 Rated current 40 A
 Rated voltage 690 V
 Rated impulse voltage 8 kV
 Pollution degree 3

Rated voltage
 acc. to UL 600 V
 Insulation resistance ≥ 10¹⁰ Ω
 Material polycarbonate
 Limiting temperatures -40 °C ... +125 °C
 Flammability acc. to UL 94 V 0
 Mechanical working life
 - mating cycles ≥ 500

Contacts

Material copper alloy
 Surface
 - hard-silver plated 3 μm Ag
 Contact resistance 0.3 mΩ

Screw terminal
 - Wire gauge ¹⁾ 2.5 ... 10 mm²
 - AWG 14 ... 8
 - Hexagonal driver SW 2
 - Stripping length

| | | | | |
|-----------------|-----------------|-----------------|-----------------|------------------|
| mm ² | 2.5 | 4 | 6 | 10 |
| mm | 5 ⁺¹ | 5 ⁺¹ | 8 ⁺¹ | 11 ⁺¹ |

- Tightening torque

| | | | | |
|-----------------|-----|-----|---|----|
| mm ² | 2.5 | 4 | 6 | 10 |
| Nm | 1.5 | 1.5 | 2 | 2 |

Current carrying capacity

The current carrying capacity of the connectors is limited by the thermal load capability of the contact element material including the connections and the insulating parts. The derating curve is therefore valid for currents which flow constantly (non-intermittent) through each contact element of the connector evenly, without exceeding the allowed maximum temperature.

Measuring and testing techniques according to DIN EN 60 512-5

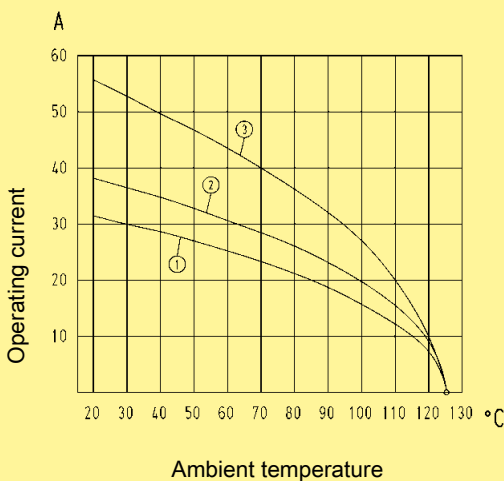

① 24 B hoods/housings with 6 modules; wire gauge: 4 mm²

② 24 B hoods/housings with 6 modules; wire gauge: 6 mm²

③ 24 B hoods/housings with 6 modules; wire gauge: 10 mm²

1) geometric wire gauge

Number of contacts

3

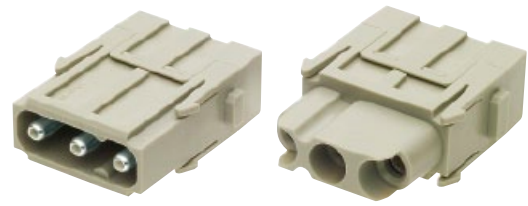

| Identification | Part number | | Drawing | Dimensions in mm |
|------------------------------|-----------------------|-----------------------|---------|------------------|
| | Male insert (M) | Female insert (F) | | |
| Axial screw terminal 40 A | | | | |
| 2.5 ... 8 mm ² | 09 14 003 2601 | 09 14 003 2701 | | |
| 6 ... 10 mm ² | 09 14 003 2602 | 09 14 003 2702 | | |

Han
Modular

| Identification | Part number | Drawing | Dimensions in mm |
|------------------------------------|-----------------------|---------|------------------|
| Hex key SW 2 for axial setscrew | | | |
| with grip | 09 99 000 0313 | | |
| Bit 1/4" | 09 99 000 0369 | | |



Features

- Suitable for Han® C crimp contacts
- Standard module for power up to 40 A
- Compatible to Han® C module with axial screw terminal

Technical characteristics

Specifications DIN EN 60 664-1
DIN EN 61 984

Approvals

Inserts

| | |
|--------------------------------------|------------------------------|
| Number of contacts | 3 |
| Electrical data acc. to EN 61 984 | |
| Cable diameter up to 5 mm | 40 A 400/690 V 6 kV 3 |
| Rated current | 40 A |
| Rated voltage conductor - ground | 400 V |
| Rated voltage conductor - conductor | 690 V |
| Rated impulse voltage | 6 kV |
| Pollution degree | 3 |

| | |
|-----------------------------|--------------------------|
| Cable diameter up to 7.5 mm | 40 A 500 V 6 kV 3 |
| Rated current | 40 A |
| Rated voltage | 500 V |
| Rated impulse voltage | 6 kV |
| Pollution degree | 3 |

| | |
|--|-----------------------|
| Rated voltage acc. to UL/CSA | 600 V |
| Rated current acc. to UL/CSA | 32 A |
| Insulation resistance | $\geq 10^{10} \Omega$ |
| Material | polycarbonate |
| Limiting temperatures | -40 °C ... +125 °C |
| Flammability acc. to UL 94 | V 0 |
| Mechanical working life - mating cycles | ≥ 500 |

Contacts

| | |
|----------------------|----------------------------|
| Material | copper alloy |
| Surface | |
| - hard-silver plated | 3 μm Ag |
| Contact resistance | $\leq 0.3 \text{ m}\Omega$ |
| Crimp terminal | |
| - mm ² | 1.5 ... 10 mm ² |
| - AWG | 16 ... 8 |

Current carrying capacity

The current carrying capacity of the connectors is limited by the thermal load capability of the contact element material including the connections and the insulating parts. The derating curve is therefore valid for currents which flow constantly (non-intermittent) through each contact element of the connector evenly, without exceeding the allowed maximum temperature.

Measuring and testing techniques according to
DIN EN 60 512-5

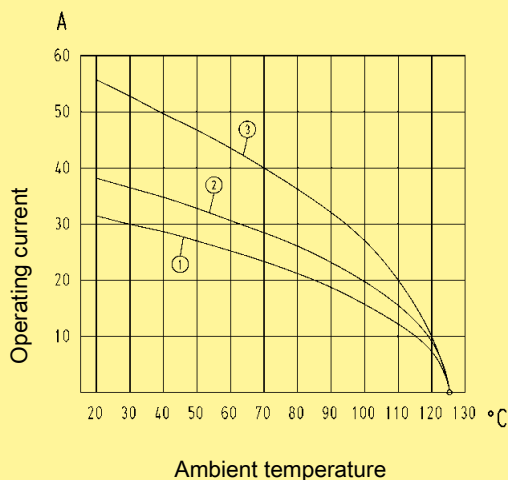

① 24 B hoods/housings with 6 modules; wire gauge: 4 mm²

② 24 B hoods/housings with 6 modules; wire gauge: 6 mm²

③ 24 B hoods/housings with 6 modules; wire gauge: 10 mm²

Number of contacts

3



| Identification | Part number | | Drawing | Dimensions in mm | |
|---|-----------------|-------------------|---------|--|----------------|
| | Male insert (M) | Female insert (F) | | | |
| Crimp terminal Order crimp contacts separately | 09 14 003 3001 | 09 14 003 3101 | | | h_M |
| | | | | 09 14 003 3002 | 09 14 003 3102 |
| Cable diameter up to 5 mm | 09 14 003 3001 | 09 14 003 3101 | | | h_F |
| Cable diameter up to 7.5 mm | 09 14 003 3002 | 09 14 003 3102 | | | |
| | | | | Contact arrangement view from termination side | |

Han Modular

| Identification | Wire gauge (mm ²) | Part number | | Drawing | Dimensions in mm | | | | | | | | | | | | | | | | | | | | | | | | |
|---|-------------------------------|----------------|------------------|---------|---|----------------|----------------|---|------------------|---------------------|--------|------|------|---------------------|--------|------|------|-------------------|--------|------|--------|-------------------|--------|-----|--------|--------------------|-------|-----|-------|
| | | Male contact | Female contact | | | | | | | | | | | | | | | | | | | | | | | | | | |
| Crimp contacts Power contacts silver plated | | | | | | | | | | | | | | | | | | | | | | | | | | | | | |
| | | | | | 1.5 | 09 32 000 6104 | 09 32 000 6204 | | | | | | | | | | | | | | | | | | | | | | |
| | | | | | 2.5 | 09 32 000 6105 | 09 32 000 6205 | | | | | | | | | | | | | | | | | | | | | | |
| | | | | | 4 | 09 32 000 6107 | 09 32 000 6207 | | | | | | | | | | | | | | | | | | | | | | |
| | | | | | 6 | 09 32 000 6108 | 09 32 000 6208 | | | | | | | | | | | | | | | | | | | | | | |
| 10* | 09 32 000 6109 | 09 32 000 6209 | | | | | | | | | | | | | | | | | | | | | | | | | | | |
| | | | | | <table border="1"> <thead> <tr> <th colspan="2">Wire gauge</th> <th>∅</th> <th>Stripping length</th> </tr> </thead> <tbody> <tr> <td>1.5 mm²</td> <td>AWG 16</td> <td>1.75</td> <td>9 mm</td> </tr> <tr> <td>2.5 mm²</td> <td>AWG 14</td> <td>2.25</td> <td>9 mm</td> </tr> <tr> <td>4 mm²</td> <td>AWG 12</td> <td>2.85</td> <td>9.6 mm</td> </tr> <tr> <td>6 mm²</td> <td>AWG 10</td> <td>3.5</td> <td>9.6 mm</td> </tr> <tr> <td>10 mm²</td> <td>AWG 8</td> <td>4.3</td> <td>15 mm</td> </tr> </tbody> </table> | Wire gauge | | ∅ | Stripping length | 1.5 mm ² | AWG 16 | 1.75 | 9 mm | 2.5 mm ² | AWG 14 | 2.25 | 9 mm | 4 mm ² | AWG 12 | 2.85 | 9.6 mm | 6 mm ² | AWG 10 | 3.5 | 9.6 mm | 10 mm ² | AWG 8 | 4.3 | 15 mm |
| Wire gauge | | ∅ | Stripping length | | | | | | | | | | | | | | | | | | | | | | | | | | |
| 1.5 mm ² | AWG 16 | 1.75 | 9 mm | | | | | | | | | | | | | | | | | | | | | | | | | | |
| 2.5 mm ² | AWG 14 | 2.25 | 9 mm | | | | | | | | | | | | | | | | | | | | | | | | | | |
| 4 mm ² | AWG 12 | 2.85 | 9.6 mm | | | | | | | | | | | | | | | | | | | | | | | | | | |
| 6 mm ² | AWG 10 | 3.5 | 9.6 mm | | | | | | | | | | | | | | | | | | | | | | | | | | |
| 10 mm ² | AWG 8 | 4.3 | 15 mm | | | | | | | | | | | | | | | | | | | | | | | | | | |
| | | | | | Stripping length a = 15 mm for cables ≥ 5 mm Stripping length a = 18 mm for cables ≥ 6.4 mm | | | | | | | | | | | | | | | | | | | | | | | | |

* for modules 09 14 003 3002 and 09 14 003 3102 only

Stock items in bold type

Features

- Suitable for Han® C crimp contacts
- Designed for a high working voltage up to 830 V
- Finger safe male and female contacts
- High contact density

Technical characteristics

Specifications DIN EN 60 664-1
DIN EN 61 984

Approvals

Inserts

| | |
|--------------------------------------|--------------------------|
| Number of contacts | 4 |
| Electrical data acc. to EN 61 984 | 40 A 830 V 8 kV 3 |
| Rated current | 40 A |
| Rated voltage | 830 V |
| Rated impulse voltage | 8 kV |
| Pollution degree | 3 |

| | |
|--|----------------------|
| Rated voltage acc. to UL | 600 V |
| Insulation resistance | ≥ 10 ¹⁰ Ω |
| Material | polycarbonate |
| Limiting temperatures | -40 °C ... +125 °C |
| Flammability acc. to UL 94 | V 0 |
| Mechanical working life - mating cycles | ≥ 500 |

Contacts

| | |
|----------------------|---------------------------|
| Material | copper alloy |
| Surface | |
| - hard-silver plated | 3 μm Ag |
| Contact resistance | ≤ 0.3 mΩ |
| Crimp terminal | |
| - mm ² | 1.5 ... 6 mm ² |
| - AWG | 16 ... 10 |

Current carrying capacity

The current carrying capacity of the connectors is limited by the thermal load capability of the contact element material including the connections and the insulating parts. The derating curve is therefore valid for currents which flow constantly (non-intermittent) through each contact element of the connector evenly, without exceeding the allowed maximum temperature.

Measuring and testing techniques according to DIN EN 60 512-5

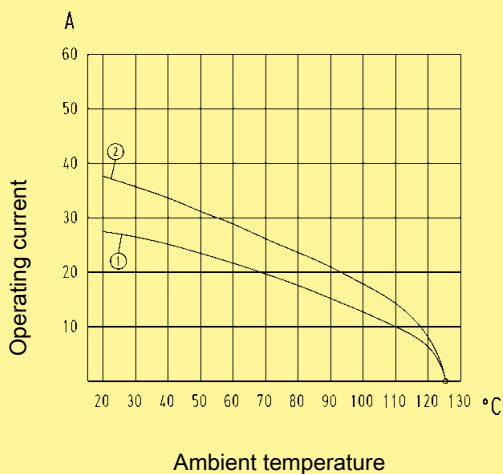

① 24 B hoods/housings with 6 modules; wire gauge: 4 mm²

② 24 B hoods/housings with 6 modules; wire gauge: 6 mm²

Number of contacts

4

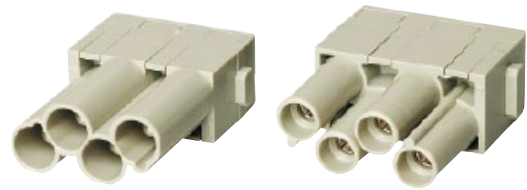

| Identification | Part number | | Drawing | Dimensions in mm |
|---|-----------------------|-----------------------|---------|------------------|
| | Male insert (M) | Female insert (F) | | |
| Crimp terminal Order crimp contacts separately | 09 14 004 3041 | 09 14 004 3141 | | |

Han Modular

| Identification | Wire gauge (mm ²) | Part number | | Drawing | Dimensions in mm | | | | | | | | | | | | | | | | | | | | |
|---|-------------------------------|--|--|---------|--|------------|--|---|------------------|---------------------|--------|------|------|---------------------|--------|------|------|-------------------|--------|------|--------|-------------------|--------|-----|--------|
| | | Male contact | Female contact | | | | | | | | | | | | | | | | | | | | | | |
| Crimp contacts Power contacts silver plated | 1.5 2.5 4 6 | 09 32 000 6104 09 32 000 6105 09 32 000 6107 09 32 000 6108 | 09 32 000 6204 09 32 000 6205 09 32 000 6207 09 32 000 6208 | | <table border="1"> <thead> <tr> <th colspan="2">Wire gauge</th> <th>∅</th> <th>Stripping length</th> </tr> </thead> <tbody> <tr> <td>1.5 mm²</td> <td>AWG 16</td> <td>1.75</td> <td>9 mm</td> </tr> <tr> <td>2.5 mm²</td> <td>AWG 14</td> <td>2.25</td> <td>9 mm</td> </tr> <tr> <td>4 mm²</td> <td>AWG 12</td> <td>2.85</td> <td>9.6 mm</td> </tr> <tr> <td>6 mm²</td> <td>AWG 10</td> <td>3.5</td> <td>9.6 mm</td> </tr> </tbody> </table> | Wire gauge | | ∅ | Stripping length | 1.5 mm ² | AWG 16 | 1.75 | 9 mm | 2.5 mm ² | AWG 14 | 2.25 | 9 mm | 4 mm ² | AWG 12 | 2.85 | 9.6 mm | 6 mm ² | AWG 10 | 3.5 | 9.6 mm |
| Wire gauge | | ∅ | Stripping length | | | | | | | | | | | | | | | | | | | | | | |
| 1.5 mm ² | AWG 16 | 1.75 | 9 mm | | | | | | | | | | | | | | | | | | | | | | |
| 2.5 mm ² | AWG 14 | 2.25 | 9 mm | | | | | | | | | | | | | | | | | | | | | | |
| 4 mm ² | AWG 12 | 2.85 | 9.6 mm | | | | | | | | | | | | | | | | | | | | | | |
| 6 mm ² | AWG 10 | 3.5 | 9.6 mm | | | | | | | | | | | | | | | | | | | | | | |

Features

- 3 contacts (40 A) for power circuits and 4 contacts (10 A) for signal circuits
- Ideal as motor drive connector
- Male and female contacts are finger safe

Technical characteristics

Specifications DIN EN 60 664-1
DIN EN 61 984

Approvals

Inserts

| | |
|--------------------------------------|--------------------------|
| Number of contacts | 3 / 4 |
| Electrical data acc. to EN 61 984 | |
| Power contacts | 40 A 830 V 8 kV 3 |
| Rated current | 40 A |
| Rated voltage | 830 V |
| Rated impulse voltage | 8 kV |
| Pollution degree | 3 |

| | |
|-----------------------|--------------------------|
| Signal contacts | 10 A 830 V 8 kV 3 |
| Rated current | 10 A |
| Rated voltage | 830 V |
| Rated impulse voltage | 8 kV |
| Pollution degree | 3 |

| | |
|--|----------------------|
| Rated voltage acc. to UL | 600 V |
| Insulation resistance | ≥ 10 ¹⁰ Ω |
| Material | polycarbonate |
| Limiting temperatures | -40 °C ... +125 °C |
| Flammability acc. to UL 94 | V 0 |
| Mechanical working life - mating cycles | ≥ 500 |

Contacts

| | |
|--------------------------|------------------------------|
| Material | copper alloy |
| Surface | |
| - hard-silver plated | 3 µm Ag |
| - hard-gold plated | 2 µm Au over 3 µm Ni |
| Contact resistance | |
| Power contacts | ≤ 0.3 mΩ |
| Signal contacts | ≤ 3 mΩ |
| Crimp terminal | |
| - mm ² | |
| Power contacts | 1.5 ... 6 mm ² |
| Signal contacts | 0.14 ... 2.5 mm ² |
| - AWG | |
| Power contacts | 16 ... 10 |
| Signal contacts | 26 ... 14 |
| Max. insulation diameter | |
| - Power contacts | 5 mm |

Current carrying capacity

The current carrying capacity of the connectors is limited by the thermal load capability of the contact element material including the connections and the insulating parts. The derating curve is therefore valid for currents which flow constantly (non-intermittent) through each contact element of the connector evenly, without exceeding the allowed maximum temperature.

Measuring and testing techniques according to DIN EN 60 512-5

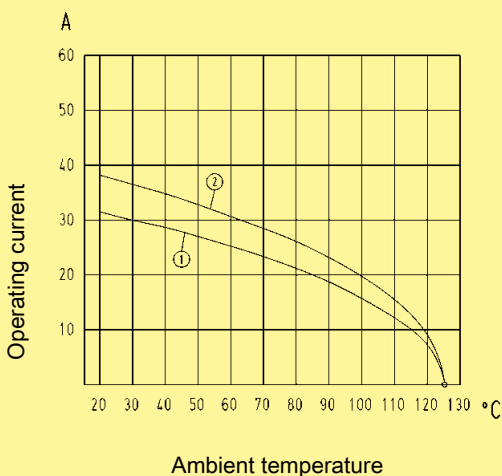

① 24 B hoods/housings with 6 modules; wire gauge: 4 mm²

② 24 B hoods/housings with 6 modules; wire gauge: 6 mm²

Number of contacts

3 / 4

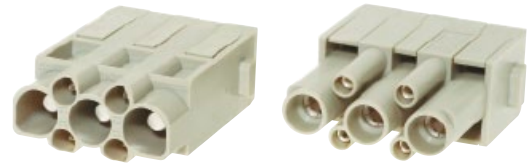

| Identification | Part number | | Drawing | Dimensions in mm |
|--|-----------------------|-----------------------|--|------------------|
| | Male insert (M) | Female insert (F) | | |
| <p>Crimp terminal</p> <p>Order crimp contacts separately</p> | 09 14 007 3001 | 09 14 007 3101 | | |
| | | | Contact arrangement view from termination side | |

Han Modular

| Identification | Wire gauge (mm²) | Part number | | Drawing | Dimensions in mm | | | | | | | | | | | | | | | | | | | | | | | | | | | | |
|---|--|---|---|--|------------------|--|---|------------------|---------------|-----------|------|------|---------|--------|------|------|----------|--------|------|--------|-------|--------|------|--------|---------|--------|------|------|---------|--------|------|------|--|
| | | Male contact | Female contact | | | | | | | | | | | | | | | | | | | | | | | | | | | | | | |
| <p>Crimp contacts</p> <p>Power contacts</p> | | | | | | | | | | | | | | | | | | | | | | | | | | | | | | | | | |
| <p>silver plated</p> | <p>1.5</p> <p>2.5</p> <p>4</p> <p>6</p> | <p>09 32 000 6104</p> <p>09 32 000 6105</p> <p>09 32 000 6107</p> <p>09 32 000 6108</p> | <p>09 32 000 6204</p> <p>09 32 000 6205</p> <p>09 32 000 6207</p> <p>09 32 000 6208</p> | <table border="1"> <thead> <tr> <th colspan="2">Wire gauge</th> <th>∅</th> <th>Stripping length</th> </tr> </thead> <tbody> <tr> <td>1.5 mm²</td> <td>AWG 16</td> <td>1.75</td> <td>9 mm</td> </tr> <tr> <td>2.5 mm²</td> <td>AWG 14</td> <td>2.25</td> <td>9 mm</td> </tr> <tr> <td>4 mm²</td> <td>AWG 12</td> <td>2.85</td> <td>9.6 mm</td> </tr> <tr> <td>6 mm²</td> <td>AWG 10</td> <td>3.5</td> <td>9.6 mm</td> </tr> </tbody> </table> | Wire gauge | | ∅ | Stripping length | 1.5 mm² | AWG 16 | 1.75 | 9 mm | 2.5 mm² | AWG 14 | 2.25 | 9 mm | 4 mm² | AWG 12 | 2.85 | 9.6 mm | 6 mm² | AWG 10 | 3.5 | 9.6 mm | | | | | | | | | |
| Wire gauge | | ∅ | Stripping length | | | | | | | | | | | | | | | | | | | | | | | | | | | | | | |
| 1.5 mm² | AWG 16 | 1.75 | 9 mm | | | | | | | | | | | | | | | | | | | | | | | | | | | | | | |
| 2.5 mm² | AWG 14 | 2.25 | 9 mm | | | | | | | | | | | | | | | | | | | | | | | | | | | | | | |
| 4 mm² | AWG 12 | 2.85 | 9.6 mm | | | | | | | | | | | | | | | | | | | | | | | | | | | | | | |
| 6 mm² | AWG 10 | 3.5 | 9.6 mm | | | | | | | | | | | | | | | | | | | | | | | | | | | | | | |
| <p>Signal contacts</p> <p>silver plated</p> | <p>0.14-0.37</p> <p>0.5</p> <p>0.75</p> <p>1</p> <p>1.5</p> <p>2.5</p> | <p>09 15 000 6104</p> <p>09 15 000 6103</p> <p>09 15 000 6105</p> <p>09 15 000 6102</p> <p>09 15 000 6101</p> <p>09 15 000 6106</p> | <p>09 15 000 6204</p> <p>09 15 000 6203</p> <p>09 15 000 6205</p> <p>09 15 000 6202</p> <p>09 15 000 6201</p> <p>09 15 000 6206</p> | | | | | | | | | | | | | | | | | | | | | | | | | | | | | | |
| <p>gold plated</p> | <p>0.14-0.37</p> <p>0.5</p> <p>0.75</p> <p>1</p> <p>1.5</p> <p>2.5</p> | <p>09 15 000 6124</p> <p>09 15 000 6123</p> <p>09 15 000 6125</p> <p>09 15 000 6122</p> <p>09 15 000 6121</p> <p>09 15 000 6126</p> | <p>09 15 000 6224</p> <p>09 15 000 6223</p> <p>09 15 000 6225</p> <p>09 15 000 6222</p> <p>09 15 000 6221</p> <p>09 15 000 6226</p> | <table border="1"> <thead> <tr> <th colspan="2">Wire gauge</th> <th>∅</th> <th>Stripping length</th> </tr> </thead> <tbody> <tr> <td>0.14-0.37 mm²</td> <td>AWG 26-22</td> <td>0.9</td> <td>8 mm</td> </tr> <tr> <td>0.5 mm²</td> <td>AWG 20</td> <td>1.1</td> <td>8 mm</td> </tr> <tr> <td>0.75 mm²</td> <td>AWG 18</td> <td>1.3</td> <td>8 mm</td> </tr> <tr> <td>1 mm²</td> <td>AWG 18</td> <td>1.45</td> <td>8 mm</td> </tr> <tr> <td>1.5 mm²</td> <td>AWG 16</td> <td>1.75</td> <td>8 mm</td> </tr> <tr> <td>2.5 mm²</td> <td>AWG 14</td> <td>2.25</td> <td>6 mm</td> </tr> </tbody> </table> | Wire gauge | | ∅ | Stripping length | 0.14-0.37 mm² | AWG 26-22 | 0.9 | 8 mm | 0.5 mm² | AWG 20 | 1.1 | 8 mm | 0.75 mm² | AWG 18 | 1.3 | 8 mm | 1 mm² | AWG 18 | 1.45 | 8 mm | 1.5 mm² | AWG 16 | 1.75 | 8 mm | 2.5 mm² | AWG 14 | 2.25 | 6 mm | |
| Wire gauge | | ∅ | Stripping length | | | | | | | | | | | | | | | | | | | | | | | | | | | | | | |
| 0.14-0.37 mm² | AWG 26-22 | 0.9 | 8 mm | | | | | | | | | | | | | | | | | | | | | | | | | | | | | | |
| 0.5 mm² | AWG 20 | 1.1 | 8 mm | | | | | | | | | | | | | | | | | | | | | | | | | | | | | | |
| 0.75 mm² | AWG 18 | 1.3 | 8 mm | | | | | | | | | | | | | | | | | | | | | | | | | | | | | | |
| 1 mm² | AWG 18 | 1.45 | 8 mm | | | | | | | | | | | | | | | | | | | | | | | | | | | | | | |
| 1.5 mm² | AWG 16 | 1.75 | 8 mm | | | | | | | | | | | | | | | | | | | | | | | | | | | | | | |
| 2.5 mm² | AWG 14 | 2.25 | 6 mm | | | | | | | | | | | | | | | | | | | | | | | | | | | | | | |

Stock items in bold type

Features

- Suitable for Han E[®] crimp contacts
- Standard module for power up to 40 A

Technical characteristics

Specifications DIN EN 60 664-1
DIN EN 61 984

Approvals

Inserts

| | |
|--------------------------------------|--------------------------|
| Number of contacts | 6 |
| Electrical data acc. to EN 61 984 | 16 A 500 V 6 kV 3 |
| Rated current | 16 A |
| Rated voltage | 500 V |
| Rated impulse voltage | 6 kV |
| Pollution degree | 3 |

| | |
|--|----------------------|
| Rated voltage acc. to UL/CSA | 600 V |
| Insulation resistance | ≥ 10 ¹⁰ Ω |
| Material | polycarbonate |
| Limiting temperatures | -40 °C ... +125 °C |
| Flammability acc. to UL 94 | V 0 |
| Mechanical working life - mating cycles | ≥ 500 |

Contacts

| | |
|--------------------|--|
| Material | copper alloy |
| Surface | - hard-silver plated - hard-gold plated |
| Contact resistance | 3 μm Ag 2 μm Au over 3 μm Ni ≤ 1 mΩ |
| Crimp terminal | - mm ² - AWG |
| | 0.14 ... 4 mm ² 26 ... 12 |

Current carrying capacity

The current carrying capacity of the connectors is limited by the thermal load capability of the contact element material including the connections and the insulating parts. The derating curve is therefore valid for currents which flow constantly (non-intermittent) through each contact element of the connector evenly, without exceeding the allowed maximum temperature.

Measuring and testing techniques according to DIN EN 60 512-5

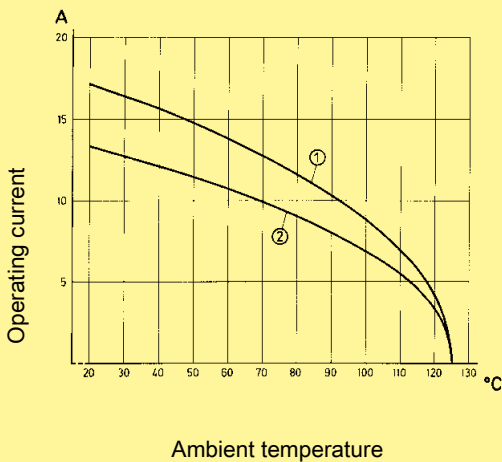

① 24 B hoods/housings with 6 modules; wire gauge: 2.5 mm²

② 24 B hoods/housings with 6 modules; wire gauge: 1.5 mm²

Number of contacts

6

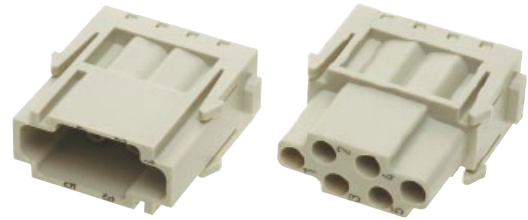

| Identification | Part number | | Drawing | Dimensions in mm |
|---|-----------------------|-----------------------|---|------------------|
| | Male insert (M) | Female insert (F) | | |
| Crimp terminal Order crimp contacts separately | 09 14 006 3001 | 09 14 006 3101 | <p style="text-align: center;">Contact arrangement view from termination side</p> | |

Han Modular

| Identification | Wire gauge (mm²) | Part number | | Drawing | Dimensions in mm |
|----------------------------------|---|--|--|--------------------------------------|-------------------|
| | | Male contact | Female contact | | |
| Crimp contacts Power contacts | | | | | |
| silver plated | 0,14-0,37 0,5 0,75 1 1,5 2,5 3 4 | 09 33 000 6127 09 33 000 6121 09 33 000 6114 09 33 000 6105 09 33 000 6104 09 33 000 6102 09 33 000 6106 09 33 000 6107 | 09 33 000 6227 09 33 000 6220 09 33 000 6214 09 33 000 6205 09 33 000 6204 09 33 000 6202 09 33 000 6206 09 33 000 6207 | Operating contact Identification | Relay contact |
| gold plated | 0,14-0,37 0,5 0,75 1 1,5 2,5 4 | 09 33 000 6117 09 33 000 6122 09 33 000 6115 09 33 000 6118 09 33 000 6116 09 33 000 6123 09 33 000 6119 | 09 33 000 6217 09 33 000 6222 09 33 000 6215 09 33 000 6218 09 33 000 6216 09 33 000 6223 09 33 000 6221 | Relay contact Identification | |
| Relay contact silver plated | 0,75-1 1,5 2,5 | 09 33 000 6109 09 33 000 6110 09 33 000 6111 | | | |

| Identification | Wire gauge | Stripping length |
|----------------|---------------|------------------|
| no groove | 0.14-0.37 mm² | AWG 26-22 |
| no groove | 0.5 mm² | AWG 20 |
| 1 groove* | 0.75 mm² | AWG 18 |
| 1 groove | 1 mm² | AWG 18 |
| 2 grooves | 1.5 mm² | AWG 16 |
| 3 grooves | 2.5 mm² | AWG 14 |
| wide groove | 3 mm² | AWG 12 |
| no groove | 4 mm² | AWG 12 |

* on the back crimp collar

Crimp contacts 0.14 ... 0.37 mm² only used with BUCHANAN crimping tool 09 99 000 0001

Stock items in bold type

Features

- Suitable for Han E® crimp contacts
- High contact density
- Compatible to the Han® EE module with Quick Lock terminal

Technical characteristics

Specifications DIN EN 60 664-1
DIN EN 61 984

Approvals 

Inserts

| | |
|--------------------------------------|--------------------------|
| Number of contacts | 8 |
| Electrical data acc. to EN 61 984 | 16 A 400 V 6 kV 3 |
| Rated current | 16 A |
| Rated voltage | 400 V |
| Rated impulse voltage | 6 kV |
| Pollution degree | 3 |

| | |
|--|-----------------------|
| Rated voltage acc. to UL | 600 V |
| Insulation resistance | $\geq 10^{10} \Omega$ |
| Material | polycarbonate |
| Limiting temperatures | -40 °C ... +125 °C |
| Flammability acc. to UL 94 | V 0 |
| Mechanical working life - mating cycles | ≥ 500 |

Contacts

| | |
|----------------------|--|
| Material | copper alloy |
| Surface | |
| - hard-silver plated | 3 μm Ag |
| - hard-gold plated | 2 μm Au over 3 μm Ni |
| Contact resistance | $\leq 1 \text{ m}\Omega$ |
| Crimp terminal | |
| - mm ² | 0.14 ... 4 mm ² |
| - AWG | 26 ... 12 |

Current carrying capacity

The current carrying capacity of the connectors is limited by the thermal load capability of the contact element material including the connections and the insulating parts. The derating curve is therefore valid for currents which flow constantly (non-intermittent) through each contact element of the connector evenly, without exceeding the allowed maximum temperature.

Measuring and testing techniques according to
DIN EN 60 512-5

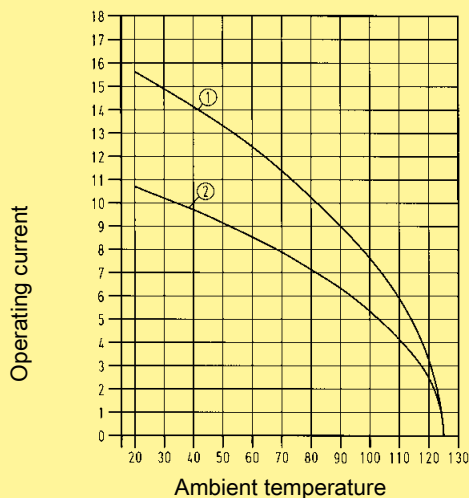

① 24 B hoods/housings with 6 modules; wire gauge: 2.5 mm²

② 24 B hoods/housings with 6 modules; wire gauge: 1.5 mm²

Number of contacts

8

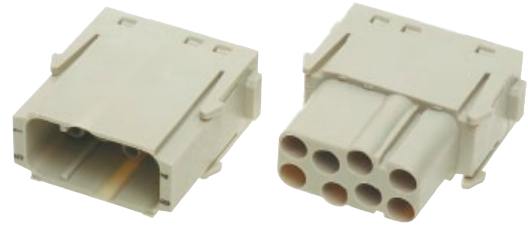

| Identification | Part number | | Drawing | Dimensions in mm |
|---|-----------------------|-----------------------|---|------------------|
| | Male insert (M) | Female insert (F) | | |
| Crimp terminal Order crimp contacts separately | 09 14 008 3001 | 09 14 008 3101 | <p style="text-align: center;">Contact arrangement view from termination side</p> | |

Han Modular

| Identification | Wire gauge (mm²) | Part number | | Drawing | Dimensions in mm |
|------------------------------------|------------------|-----------------------|-----------------------|---------|------------------|
| | | Male contact | Female contact | | |
| Crimp contacts Power contacts | | | | | |
| silver plated | 0.14-0.37 | 09 33 000 6127 | 09 33 000 6227 | | |
| | 0.5 | 09 33 000 6121 | 09 33 000 6220 | | |
| | 0.75 | 09 33 000 6114 | 09 33 000 6214 | | |
| | 1 | 09 33 000 6105 | 09 33 000 6205 | | |
| | 1.5 | 09 33 000 6104 | 09 33 000 6204 | | |
| | 2.5 | 09 33 000 6102 | 09 33 000 6202 | | |
| | 3 | 09 33 000 6106 | 09 33 000 6206 | | |
| | 4 | 09 33 000 6107 | 09 33 000 6207 | | |
| gold plated | 0.14-0.37 | 09 33 000 6117 | 09 33 000 6217 | | |
| | 0.5 | 09 33 000 6122 | 09 33 000 6222 | | |
| | 0.75 | 09 33 000 6115 | 09 33 000 6215 | | |
| | 1 | 09 33 000 6118 | 09 33 000 6218 | | |
| | 1.5 | 09 33 000 6116 | 09 33 000 6216 | | |
| | 2.5 | 09 33 000 6123 | 09 33 000 6223 | | |
| | 4 | 09 33 000 6119 | 09 33 000 6221 | | |
| Relay contact silver plated | 0.75-1 | 09 33 000 6109 | | | |
| | 1.5 | 09 33 000 6110 | | | |
| | 2.5 | 09 33 000 6111 | | | |

| Identification | Wire gauge | Stripping length |
|----------------|---------------|------------------|
| no groove | 0.14-0.37 mm² | AWG 26-22 |
| no groove | 0.5 mm² | AWG 20 |
| 1 groove* | 0.75 mm² | AWG 18 |
| 1 groove | 1 mm² | AWG 18 |
| 2 grooves | 1.5 mm² | AWG 16 |
| 3 grooves | 2.5 mm² | AWG 14 |
| wide groove | 3 mm² | AWG 12 |
| no groove | 4 mm² | AWG 12 |

* on the back crimp collar

Crimp contacts 0.14 ... 0.37 mm² only used with BUCHANAN crimping tool 09 99 000 0001

Stock items in bold type



Features

- Innovative Han-Quick Lock® termination technology
- Field assembly without special tools
- Compatible to Han® EE module with crimp terminal
- Reduced wiring times

Technical characteristics

Specifications DIN EN 60 664-1
 DIN EN 61 984

Approvals

Inserts

Number of contacts 8
 Electrical data
 acc. to EN 61 984 **16 A 400 V 6 kV 3**
 Rated current 16 A
 Rated voltage 400 V
 Rated impulse voltage 6 kV
 Pollution degree 3

Insulation resistance $\geq 10^{10} \Omega$
 Material polycarbonate
 Limiting temperatures -40 °C ... +125 °C
 Flammability acc. to UL 94 V 0
 Mechanical working life
 - mating cycles ≥ 500

Contacts

Material copper alloy
 Surface
 - hard-silver plated 3 μm Ag
 Contact resistance $\leq 1 \text{ m}\Omega$
 Quick Lock termination
 - mm^2 0.5 ... 2.5 mm^2
 - AWG 20 ... 14

Current carrying capacity

The current carrying capacity of the connectors is limited by the thermal load capability of the contact element material including the connections and the insulating parts. The derating curve is therefore valid for currents which flow constantly (non-intermittent) through each contact element of the connector evenly, without exceeding the allowed maximum temperature.

Measuring and testing techniques according to DIN EN 60 512-5

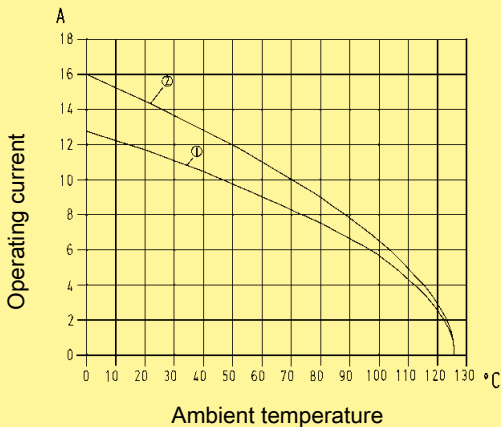

① 24 B hoods/housings with 6 modules; wire gauge: 1.5 mm^2

② 24 B hoods/housings with 6 modules; wire gauge: 2.5 mm^2



Number of contacts

8

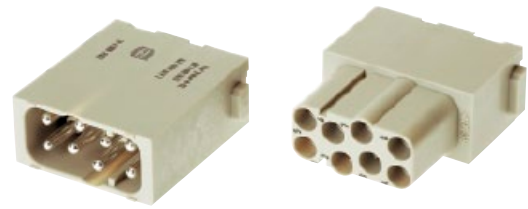

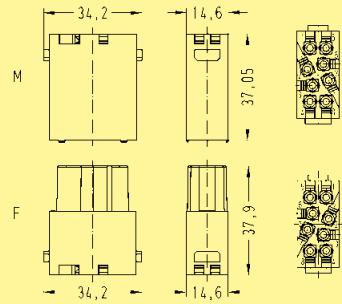
| Identification | Part number | | Drawing | Dimensions in mm |
|---|-----------------------|-----------------------|--|------------------|
| | Male insert (M) | Female insert (F) | | |
| Quick Lock termination  | 09 14 008 2633 | 09 14 008 2733 |  <p>Contact arrangement view from termination side</p> | |

Han Modular

Features

- Suitable for Han E[®] crimp contacts
- designed for a high working voltage up to 830 V
- finger safe male and female contacts

Technical characteristics

Specifications DIN EN 60 664-1
DIN EN 61 984

Approvals

Inserts

| | |
|--------------------------------------|--------------------------|
| Number of contacts | 6 |
| Electrical data acc. to EN 61 984 | 16 A 830 V 8 kV 3 |
| Rated current | 16 A |
| Rated voltage | 830 V |
| Rated impulse voltage | 8 kV |
| Pollution degree | 3 |

| | |
|--|----------------------|
| Rated voltage acc. to UL | 600 V |
| Insulation resistance | ≥ 10 ¹⁰ Ω |
| Material | polycarbonate |
| Limiting temperatures | -40 °C ... +125 °C |
| Flammability acc. to UL 94 | V 0 |
| Mechanical working life - mating cycles | ≥ 500 |

Contacts

| | |
|----------------------|----------------------------|
| Material | copper alloy |
| Surface | |
| - hard-silver plated | 3 μm Ag |
| - hard-gold plated | 2 μm Au over 3 μm Ni |
| Contact resistance | ≤ 1 mΩ |
| Crimp terminal | |
| - mm ² | 0.14 ... 4 mm ² |
| - AWG | 26 ... 12 |

Current carrying capacity

The current carrying capacity of the connectors is limited by the thermal load capability of the contact element material including the connections and the insulating parts. The derating curve is therefore valid for currents which flow constantly (non-intermittent) through each contact element of the connector evenly, without exceeding the allowed maximum temperature.

Measuring and testing techniques according to
DIN EN 60 512-5

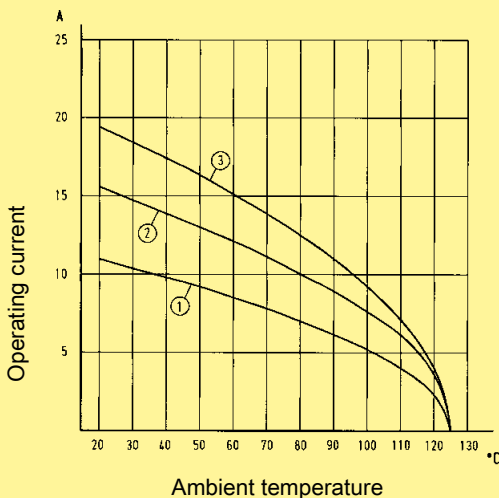

① 24 B hoods/housings with 6 modules; wire gauge: 1.5 mm²

② 24 B hoods/housings with 6 modules; wire gauge: 2.5 mm²

③ 24 B hoods/housings with 6 modules; wire gauge: 4 mm²

Number of contacts

6

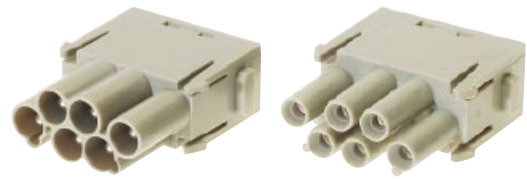

| Identification | Part number | | Drawing | Dimensions in mm |
|--|-----------------------|-----------------------|--|------------------|
| | Male insert (M) | Female insert (F) | | |
| Crimp terminal Order crimp contacts separately | 09 14 006 3041 | 09 14 006 3141 | <p>M</p> <p>F</p> <p>M F</p> <p>Contact arrangement view from termination side</p> | |

Han Modular

| Identification | Wire gauge (mm²) | Part number | | Drawing | Dimensions in mm |
|---|------------------|-----------------------|-----------------------|--|------------------|
| | | Male contact | Female contact | | |
| Crimp contacts Power contacts | | | | <p>Operating contact Identification</p> <p>Relay contact</p> | |
| silver plated | 0.14-0.37 | 09 33 000 6127 | 09 33 000 6227 | | |
| | 0.5 | 09 33 000 6121 | 09 33 000 6220 | | |
| | 0.75 | 09 33 000 6114 | 09 33 000 6214 | | |
| | 1 | 09 33 000 6105 | 09 33 000 6205 | | |
| | 1.5 | 09 33 000 6104 | 09 33 000 6204 | | |
| | 2.5 | 09 33 000 6102 | 09 33 000 6202 | | |
| | 3 | 09 33 000 6106 | 09 33 000 6206 | | |
| | 4 | 09 33 000 6107 | 09 33 000 6207 | | |
| gold plated | 0.14-0.37 | 09 33 000 6117 | 09 33 000 6217 | | |
| | 0.5 | 09 33 000 6122 | 09 33 000 6222 | | |
| | 0.75 | 09 33 000 6115 | 09 33 000 6215 | | |
| | 1 | 09 33 000 6118 | 09 33 000 6218 | | |
| | 1.5 | 09 33 000 6116 | 09 33 000 6216 | | |
| | 2.5 | 09 33 000 6123 | 09 33 000 6223 | | |
| | 4 | 09 33 000 6119 | 09 33 000 6221 | | |
| Relay contact silver plated | 0.75-1 | 09 33 000 6109 | | | |
| | 1.5 | 09 33 000 6110 | | | |
| | 2.5 | 09 33 000 6111 | | | |

| Identification | Wire gauge | | Stripping length |
|----------------|---------------|-----------|------------------|
| no groove | 0.14-0.37 mm² | AWG 26-22 | 7.5 mm |
| no groove | 0.5 mm² | AWG 20 | 7.5 mm |
| 1 groove* | 0.75 mm² | AWG 18 | 7.5 mm |
| 1 groove | 1 mm² | AWG 18 | 7.5 mm |
| 2 grooves | 1.5 mm² | AWG 16 | 7.5 mm |
| 3 grooves | 2.5 mm² | AWG 14 | 7.5 mm |
| wide groove | 3 mm² | AWG 12 | 7.5 mm |
| no groove | 4 mm² | AWG 12 | 7.5 mm |

* on the back crimp collar

Crimp contacts 0.14 ... 0.37 mm² only used with BUCHANAN crimping tool 09 99 000 0001

Stock items in bold type

Features

- Suitable for Han E® crimp contacts
- High contact density
- Up to 16 A per contact
- Also suitable as a reliable signal connector

Technical characteristics

Specifications DIN EN 60 664-1
 DIN EN 61 984

Approvals

Inserts

Number of contacts 20
 Electrical data
 acc. to EN 61 984 **16 A 500 V 6 kV 3**
 Rated current 16 A
 Rated voltage 500 V
 Rated impulse voltage 6 kV
 Pollution degree 3

Rated voltage
 acc. to UL 600 V
 Insulation resistance $\geq 10^{10} \Omega$
 Material polycarbonate
 Limiting temperatures -40 °C ... +125 °C
 Flammability acc. to UL 94 V 0
 Mechanical working life
 - mating cycles ≥ 500

Contacts

Material copper alloy
 Surface
 - hard-silver plated 3 μm Ag
 - hard-gold plated 2 μm Au over 3 μm Ni
 Contact resistance $\leq 1 \text{ m}\Omega$
 Crimp terminal
 - mm² 0.14 ... 4 mm²
 - AWG 26 ... 12

Current carrying capacity

The current carrying capacity of the connectors is limited by the thermal load capability of the contact element material including the connections and the insulating parts. The derating curve is therefore valid for currents which flow constantly (non-intermittent) through each contact element of the connector evenly, without exceeding the allowed maximum temperature.

Measuring and testing techniques according to DIN EN 60 512-5

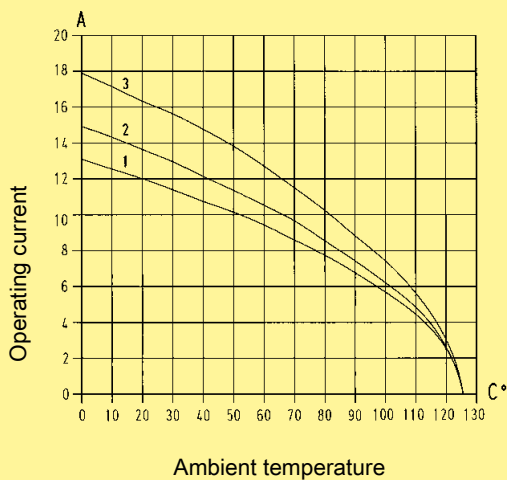

- ① 24 B hoods/housings with 3 modules; wire gauge: 1.5 mm²
 ② 24 B hoods/housings with 3 modules; wire gauge: 2.5 mm²
 ③ 24 B hoods/housings with 3 modules; wire gauge: 4 mm²

Number of contacts

20

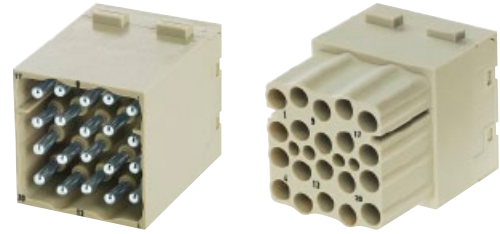

| Identification | Part number | | Drawing | Dimensions in mm |
|---|-----------------------|-----------------------|---|------------------|
| | Male insert (M) | Female insert (F) | | |
| Crimp terminal Order crimp contacts separately | 09 14 020 3001 | 09 14 020 3101 | <p>Contact arrangement view from termination side</p> | |

Han Modular

| Identification | Wire gauge (mm²) | Part number | | Drawing | Dimensions in mm |
|------------------------------------|------------------|-----------------------|-----------------------|--|------------------|
| | | Male contact | Female contact | | |
| Crimp contacts Power contacts | | | | <p>Operating contact Identification Relay contact</p> | |
| silver plated | 0.14-0.37 | 09 33 000 6127 | 09 33 000 6227 | | |
| | 0.5 | 09 33 000 6121 | 09 33 000 6220 | | |
| | 0.75 | 09 33 000 6114 | 09 33 000 6214 | | |
| | 1 | 09 33 000 6105 | 09 33 000 6205 | | |
| | 1.5 | 09 33 000 6104 | 09 33 000 6204 | | |
| | 2.5 | 09 33 000 6102 | 09 33 000 6202 | | |
| | 3 | 09 33 000 6106 | 09 33 000 6206 | | |
| | 4 | 09 33 000 6107 | 09 33 000 6207 | | |
| gold plated | 0.14-0.37 | 09 33 000 6117 | 09 33 000 6217 | | |
| | 0.5 | 09 33 000 6122 | 09 33 000 6222 | | |
| | 0.75 | 09 33 000 6115 | 09 33 000 6215 | | |
| | 1 | 09 33 000 6118 | 09 33 000 6218 | | |
| | 1.5 | 09 33 000 6116 | 09 33 000 6216 | | |
| | 2.5 | 09 33 000 6123 | 09 33 000 6223 | | |
| | 4 | 09 33 000 6119 | 09 33 000 6221 | | |
| Relay contact silver plated | 0.75-1 | 09 33 000 6109 | | | |
| | 1.5 | 09 33 000 6110 | | | |
| | 2.5 | 09 33 000 6111 | | | |

| Identification | Wire gauge | AWG | Stripping length |
|----------------|---------------|-----------|------------------|
| no groove | 0.14-0.37 mm² | AWG 26-22 | 7.5 mm |
| no groove | 0.5 mm² | AWG 20 | 7.5 mm |
| 1 groove* | 0.75 mm² | AWG 18 | 7.5 mm |
| 1 groove | 1 mm² | AWG 18 | 7.5 mm |
| 2 grooves | 1.5 mm² | AWG 16 | 7.5 mm |
| 3 grooves | 2.5 mm² | AWG 14 | 7.5 mm |
| wide groove | 3 mm² | AWG 12 | 7.5 mm |
| no groove | 4 mm² | AWG 12 | 7.5 mm |

* on the back crimp collar

Crimp contacts 0.14 ... 0.37 mm² only used with BUCHANAN crimping tool 09 99 000 0001

Stock items in bold type

Features

- Cage-clamp terminal
- No special tools required

Technical characteristics

Specifications DIN EN 60 664-1
DIN EN 61 984

Approvals

Inserts

| | |
|--------------------------------------|--------------------------|
| Number of contacts | 5 |
| Electrical data acc. to EN 61 984 | 16 A 400 V 6 kV 3 |
| Rated current | 16 A |
| Rated voltage | 400 V |
| Rated impulse voltage | 6 kV |
| Pollution degree | 3 |

| | |
|--|----------------------|
| Rated voltage acc. to UL | 600 V |
| Insulation resistance | ≥ 10 ¹⁰ Ω |
| Material | polycarbonate |
| Limiting temperatures | -40 °C ... +125 °C |
| Flammability acc. to UL 94 | V 0 |
| Mechanical working life - mating cycles | ≥ 500 |

Contacts

| | |
|---------------------|---|
| Material | copper alloy |
| Surface | - hard-silver plated |
| Contact resistance | 3 μm Ag ≤ 3 mΩ |
| Cage clamp terminal | - mm ² - AWG |
| | 0.14 ... 2.5 mm ² 26 ... 14 |

Current carrying capacity

The current carrying capacity of the connectors is limited by the thermal load capability of the contact element material including the connections and the insulating parts. The derating curve is therefore valid for currents which flow constantly (non-intermittent) through each contact element of the connector evenly, without exceeding the allowed maximum temperature.

Measuring and testing techniques according to DIN EN 60 512-5

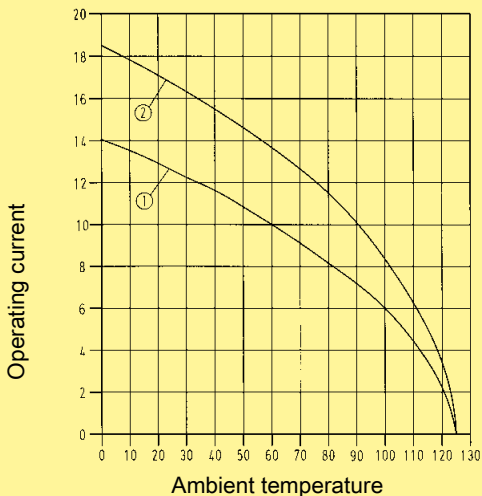

① 24 B hoods/housings with 6 modules; wire gauge: 1.5 mm²

② 24 B hoods/housings with 6 modules; wire gauge: 2.5 mm²

Number of contacts

5

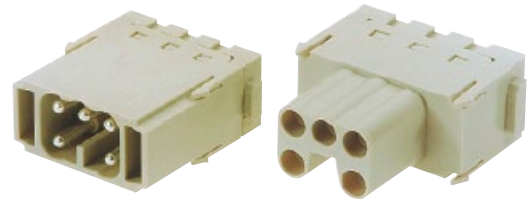

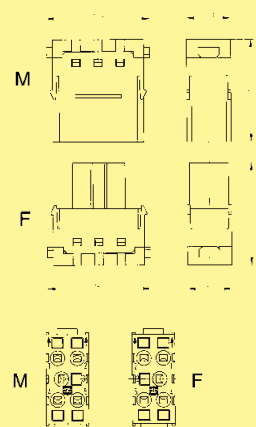
| Identification | Part number | | Drawing | Dimensions in mm |
|---------------------|-----------------------|-----------------------|--|------------------|
| | Male insert (M) | Female insert (F) | | |
| Cage-clamp terminal | 09 14 005 2616 | 09 14 005 2716 |  <p>M</p> <p>F</p> <p>M F</p> <p>Contact arrangement view from termination side</p> | |

Han Modular

06
61

Stock items in bold type

Features

- Suitable for Han E® crimp contacts
- 2 contacts up to 5000 V
- Insulator out of a voltage resistant teflon material
- Combination of all other modules (pneumatic, signal etc.)

Technical characteristics

| | |
|----------------|--|
| Specifications | DIN EN 61 984 DIN VDE 0115 DIN EN 60 664-1 |
|----------------|--|

Inserts

| | |
|--|---------------------------------|
| Number of contacts | 2 |
| Electrical data acc. to EN 61 984 | 16 A 2900/5000 V 15 kV 3 |
| Rated current | 16 A |
| Rated voltage conductor - ground | 2900 V |
| Rated voltage conductor - conductor | 5000 V |
| Rated impulse voltage | 15 kV |
| Pollution degree | 3 |
| Insulation resistance | ≥ 10 ¹⁰ Ω |
| Material | polycarbonate/Teflon (PTFE) |
| Limiting temperatures | -40 °C ... +125 °C |
| Flammability acc. to UL 94 | V 0 |
| Mechanical working life - mating cycles | ≥ 500 |

Contacts

| | |
|----------------------|---------------------------|
| Material | copper alloy |
| Surface | |
| - hard-silver plated | 3 μm Ag |
| - hard-gold plated | 2 μm Au over 3 μm Ni |
| Contact resistance | ≤ 1 mΩ |
| Crimp terminal | |
| - mm ² | 0.5 ... 4 mm ² |
| - AWG | 20 ... 12 |

Current carrying capacity

The current carrying capacity of the connectors is limited by the thermal load capability of the contact element material including the connections and the insulating parts. The derating curve is therefore valid for currents which flow constantly (non-intermittent) through each contact element of the connector evenly, without exceeding the allowed maximum temperature.

Measuring and testing techniques according to DIN EN 60 512-5

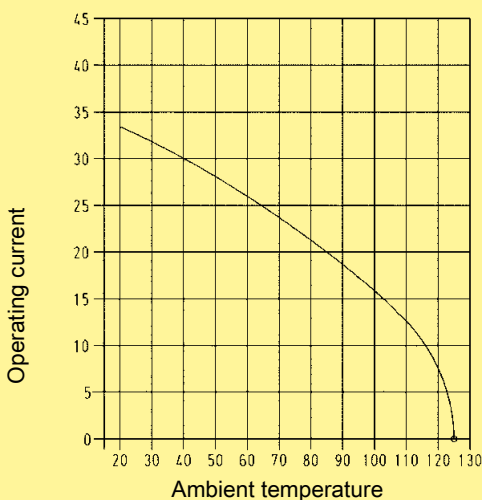

① Housing Han® 16 B with 1 Han® HV module, wire gauge: 2.5 mm²

Assembly instructions

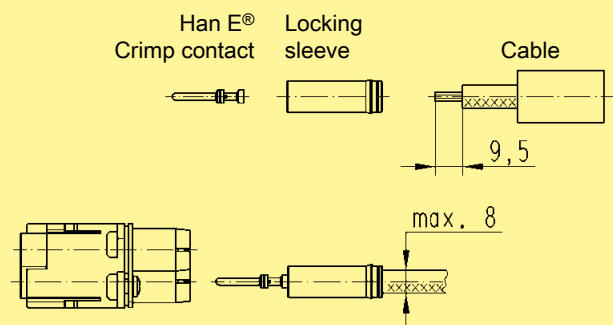

Crimp with BUCHANAN crimping tool
09 99 000 0001
Snap crimped cable in the insert

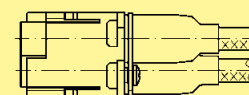

shrink the heat shrink tube over the rear of contact

Number of contacts

2

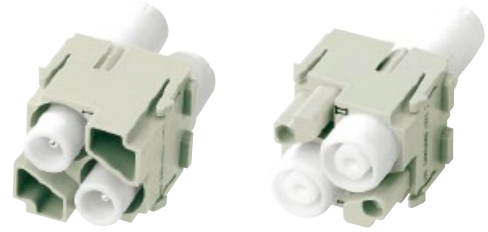

| Identification | Part number | | Drawing | Dimensions in mm |
|--|------------------------------|------------------------------|---------|------------------|
| | Male insert (M) | Female insert (F) | | |
| <p>Crimp terminal Order crimp contacts separately</p> <p>Range of delivery: - 1 module - 2 locking sleeves - 2 heat shrink tubes</p> <p>Removal tool for locking sleeve</p> | <p>09 14 002 3021</p> | <p>09 14 002 3121</p> | | |

Han Modular

| Identification | Wire gauge (mm²) | Part number | | Drawing | Dimensions in mm | | | | | | | | | | | | | | | | | | | | | | | | | | | | | | | |
|---|---|--|--|---------|---|----------------|------------|------------------|-----------|---------|--------|--------|-----------|----------|--------|--------|----------|-------|--------|--------|-----------|---------|--------|--------|-----------|---------|--------|--------|-------------|-------|--------|--------|-----------|-------|--------|--------|
| | | Male contact | Female contact | | | | | | | | | | | | | | | | | | | | | | | | | | | | | | | | | |
| <p>Crimp contacts</p> <p>silver plated</p> | <p>0.5</p> <p>0.75</p> <p>1</p> <p>1.5</p> <p>2.5</p> <p>3</p> <p>4</p> | <p>09 33 000 6121</p> <p>09 33 000 6114</p> <p>09 33 000 6105</p> <p>09 33 000 6104</p> <p>09 33 000 6102</p> <p>09 33 000 6106</p> <p>09 33 000 6107</p> | <p>09 33 000 6220</p> <p>09 33 000 6214</p> <p>09 33 000 6205</p> <p>09 33 000 6204</p> <p>09 33 000 6202</p> <p>09 33 000 6206</p> <p>09 33 000 6207</p> | | <p>Operating contact Identification</p> <table border="1"> <thead> <tr> <th>Identification</th> <th>Wire gauge</th> <th>Stripping length</th> </tr> </thead> <tbody> <tr> <td>no groove</td> <td>0.5 mm²</td> <td>AWG 20</td> <td>9.5 mm</td> </tr> <tr> <td>1 groove*</td> <td>0.75 mm²</td> <td>AWG 18</td> <td>9.5 mm</td> </tr> <tr> <td>1 groove</td> <td>1 mm²</td> <td>AWG 18</td> <td>9.5 mm</td> </tr> <tr> <td>2 grooves</td> <td>1.5 mm²</td> <td>AWG 16</td> <td>9.5 mm</td> </tr> <tr> <td>3 grooves</td> <td>2.5 mm²</td> <td>AWG 14</td> <td>9.5 mm</td> </tr> <tr> <td>wide groove</td> <td>3 mm²</td> <td>AWG 12</td> <td>9.5 mm</td> </tr> <tr> <td>no groove</td> <td>4 mm²</td> <td>AWG 12</td> <td>9.5 mm</td> </tr> </tbody> </table> <p>* on the back crimp collar</p> | Identification | Wire gauge | Stripping length | no groove | 0.5 mm² | AWG 20 | 9.5 mm | 1 groove* | 0.75 mm² | AWG 18 | 9.5 mm | 1 groove | 1 mm² | AWG 18 | 9.5 mm | 2 grooves | 1.5 mm² | AWG 16 | 9.5 mm | 3 grooves | 2.5 mm² | AWG 14 | 9.5 mm | wide groove | 3 mm² | AWG 12 | 9.5 mm | no groove | 4 mm² | AWG 12 | 9.5 mm |
| Identification | Wire gauge | Stripping length | | | | | | | | | | | | | | | | | | | | | | | | | | | | | | | | | | |
| no groove | 0.5 mm² | AWG 20 | 9.5 mm | | | | | | | | | | | | | | | | | | | | | | | | | | | | | | | | | |
| 1 groove* | 0.75 mm² | AWG 18 | 9.5 mm | | | | | | | | | | | | | | | | | | | | | | | | | | | | | | | | | |
| 1 groove | 1 mm² | AWG 18 | 9.5 mm | | | | | | | | | | | | | | | | | | | | | | | | | | | | | | | | | |
| 2 grooves | 1.5 mm² | AWG 16 | 9.5 mm | | | | | | | | | | | | | | | | | | | | | | | | | | | | | | | | | |
| 3 grooves | 2.5 mm² | AWG 14 | 9.5 mm | | | | | | | | | | | | | | | | | | | | | | | | | | | | | | | | | |
| wide groove | 3 mm² | AWG 12 | 9.5 mm | | | | | | | | | | | | | | | | | | | | | | | | | | | | | | | | | |
| no groove | 4 mm² | AWG 12 | 9.5 mm | | | | | | | | | | | | | | | | | | | | | | | | | | | | | | | | | |

Stock items in bold type

Features

- Suitable for Han® C crimp contacts
- 2 contacts up to 5000 V
- Insulator out of a voltage resistant teflon material
- Combination of all other modules (pneumatic, signal etc.)

Technical characteristics

| | |
|----------------|--|
| Specifications | DIN EN 61 984 DIN VDE 0115 DIN EN 60 664-1 |
|----------------|--|

Inserts

| | |
|--------------------------------------|---------------------------------|
| Number of contacts | 2 |
| Electrical data acc. to EN 61 984 | 40 A 2900/5000 V 15 kV 3 |
| Rated current | 40 A |
| Rated voltage conductor - ground | 2900 V |
| Rated voltage conductor - conductor | 5000 V |
| Rated impulse voltage | 15 kV |
| Pollution degree | 3 |

| | |
|--|-----------------------------|
| Insulation resistance | ≥ 10 ¹⁰ Ω |
| Material | polycarbonate/Teflon (PTFE) |
| Limiting temperatures | -40 °C ... +125 °C |
| Flammability acc. to UL 94 | V 0 |
| Max. cable diameter | 9 mm |
| Mechanical working life - mating cycles | ≥ 500 |

Contacts

| | |
|--------------------|--|
| Material | copper alloy |
| Surface | - hard-silver plated |
| Contact resistance | 3 μm Ag ≤ 0.3 mΩ |
| Crimp terminal | - mm ² - AWG |
| | 1.5 ... 10 mm ² 16 ... 8 |

Current carrying capacity

The current carrying capacity of the connectors is limited by the thermal load capability of the contact element material including the connections and the insulating parts. The derating curve is therefore valid for currents which flow constantly (non-intermittent) through each contact element of the connector evenly, without exceeding the allowed maximum temperature.

Measuring and testing techniques according to DIN EN 60 512-5

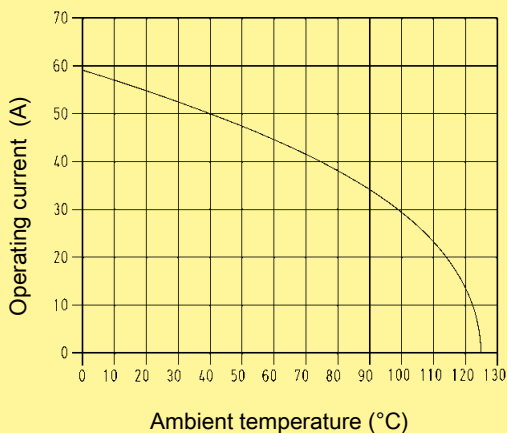

24 B hoods/housings with 3 modules; wire gauge: 6 mm²

Assembly instructions

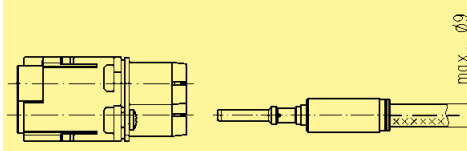
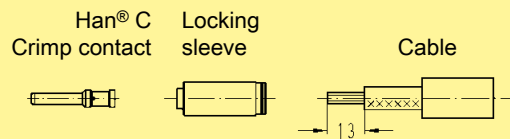

Crimp with tool 0999 000 0001, 0999 000 0110 or 0999 000 0377
Snap crimped cable in the insert

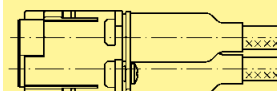

shrink the heat shrink tube over the rear of contact

Number of contacts

2

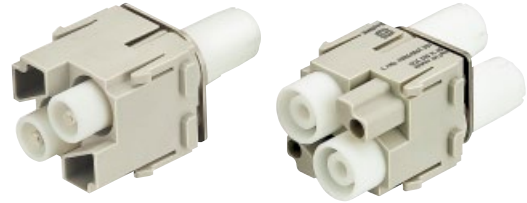

| Identification | Part number | | Drawing | Dimensions in mm |
|--|------------------------------|------------------------------|--------------------------|------------------------------|
| | Male insert (M) | Female insert (F) | | |
| <p>Crimp terminal</p> <p>Order crimp contacts separately</p> <p>Range of delivery:</p> <ul style="list-style-type: none"> - 1 module - 2 locking sleeves - 2 heat shrink tubes <p>Removal tool for locking sleeve</p> | <p>09 14 002 3023</p> | <p>09 14 002 3123</p> | <p>M</p> <p>F</p> | <p>09 99 000 0327</p> |

Han Modular

| Identification | Wire gauge (mm ²) | Part number | | Drawing | Dimensions in mm | | | | | | | | | | | | | | | | | | | | | | | | | | | | | | |
|--|---|--|--|------------------|--|------------|--|--|---|------------------|-----|-----------------|--------|------|-------|-----|-----------------|--------|------|-------|---|-----------------|--------|------|-------|---|-----------------|--------|-----|-------|----|-----------------|-------|-----|-------|
| | | Male contact | Female contact | | | | | | | | | | | | | | | | | | | | | | | | | | | | | | | | |
| <p>Crimp contacts</p> <p>Power contacts</p> <p>silver plated</p> | <p>1.5</p> <p>2.5</p> <p>4</p> <p>6</p> <p>10</p> | <p>09 32 000 6104</p> <p>09 32 000 6105</p> <p>09 32 000 6107</p> <p>09 32 000 6108</p> <p>09 32 000 6109</p> | <p>09 32 000 6204</p> <p>09 32 000 6205</p> <p>09 32 000 6207</p> <p>09 32 000 6208</p> <p>09 32 000 6209</p> | | <table border="1"> <thead> <tr> <th colspan="3">Wire gauge</th> <th>∅</th> <th>Stripping length</th> </tr> </thead> <tbody> <tr> <td>1.5</td> <td>mm²</td> <td>AWG 16</td> <td>1.75</td> <td>13 mm</td> </tr> <tr> <td>2.5</td> <td>mm²</td> <td>AWG 14</td> <td>2.25</td> <td>13 mm</td> </tr> <tr> <td>4</td> <td>mm²</td> <td>AWG 12</td> <td>2.85</td> <td>13 mm</td> </tr> <tr> <td>6</td> <td>mm²</td> <td>AWG 10</td> <td>3.5</td> <td>13 mm</td> </tr> <tr> <td>10</td> <td>mm²</td> <td>AWG 8</td> <td>4.3</td> <td>13 mm</td> </tr> </tbody> </table> | Wire gauge | | | ∅ | Stripping length | 1.5 | mm ² | AWG 16 | 1.75 | 13 mm | 2.5 | mm ² | AWG 14 | 2.25 | 13 mm | 4 | mm ² | AWG 12 | 2.85 | 13 mm | 6 | mm ² | AWG 10 | 3.5 | 13 mm | 10 | mm ² | AWG 8 | 4.3 | 13 mm |
| Wire gauge | | | ∅ | Stripping length | | | | | | | | | | | | | | | | | | | | | | | | | | | | | | | |
| 1.5 | mm ² | AWG 16 | 1.75 | 13 mm | | | | | | | | | | | | | | | | | | | | | | | | | | | | | | | |
| 2.5 | mm ² | AWG 14 | 2.25 | 13 mm | | | | | | | | | | | | | | | | | | | | | | | | | | | | | | | |
| 4 | mm ² | AWG 12 | 2.85 | 13 mm | | | | | | | | | | | | | | | | | | | | | | | | | | | | | | | |
| 6 | mm ² | AWG 10 | 3.5 | 13 mm | | | | | | | | | | | | | | | | | | | | | | | | | | | | | | | |
| 10 | mm ² | AWG 8 | 4.3 | 13 mm | | | | | | | | | | | | | | | | | | | | | | | | | | | | | | | |

06
65

Stock items in bold type

Number of contacts

12

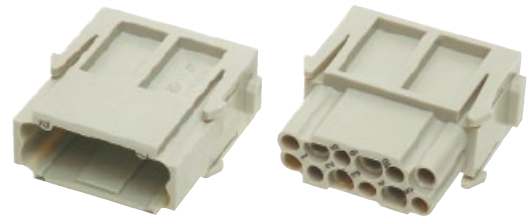

| Identification | Part number | | Drawing | Dimensions in mm |
|---|-----------------------|-----------------------|---|------------------|
| | Male insert (M) | Female insert (F) | | |
| Crimp terminal Order crimp contacts separately | 09 14 012 3001 | 09 14 012 3101 | <p>M</p> <p>F</p> <p>M</p> <p>F</p> <p>Contact arrangement view from termination side</p> | |

Han Modular

| Identification | Wire gauge (mm ²) | Part number | | Drawing | Dimensions in mm | | | | | | | | | | | | | | | | | | | | | | | | | | | | |
|---|---|--|--|---------|--|------------|--|---|------------------|---------------------------|-----------|-----|------|---------------------|--------|-----|------|----------------------|--------|-----|------|-------------------|--------|------|------|---------------------|--------|------|------|---------------------|--------|------|------|
| | | Male contact | Female contact | | | | | | | | | | | | | | | | | | | | | | | | | | | | | | |
| Crimp contacts Power contacts silver plated | 0.14-0.37 0.5 0.75 1 1.5 2.5 | 09 15 000 6104 09 15 000 6103 09 15 000 6105 09 15 000 6102 09 15 000 6101 09 15 000 6106 | 09 15 000 6204 09 15 000 6203 09 15 000 6205 09 15 000 6202 09 15 000 6201 09 15 000 6206 | | <table border="1"> <thead> <tr> <th colspan="2">Wire gauge</th> <th>∅</th> <th>Stripping length</th> </tr> </thead> <tbody> <tr> <td>0.14-0.37 mm²</td> <td>AWG 26-22</td> <td>0.9</td> <td>8 mm</td> </tr> <tr> <td>0.5 mm²</td> <td>AWG 20</td> <td>1.1</td> <td>8 mm</td> </tr> <tr> <td>0.75 mm²</td> <td>AWG 18</td> <td>1.3</td> <td>8 mm</td> </tr> <tr> <td>1 mm²</td> <td>AWG 18</td> <td>1.45</td> <td>8 mm</td> </tr> <tr> <td>1.5 mm²</td> <td>AWG 16</td> <td>1.75</td> <td>8 mm</td> </tr> <tr> <td>2.5 mm²</td> <td>AWG 14</td> <td>2.25</td> <td>6 mm</td> </tr> </tbody> </table> | Wire gauge | | ∅ | Stripping length | 0.14-0.37 mm ² | AWG 26-22 | 0.9 | 8 mm | 0.5 mm ² | AWG 20 | 1.1 | 8 mm | 0.75 mm ² | AWG 18 | 1.3 | 8 mm | 1 mm ² | AWG 18 | 1.45 | 8 mm | 1.5 mm ² | AWG 16 | 1.75 | 8 mm | 2.5 mm ² | AWG 14 | 2.25 | 6 mm |
| Wire gauge | | ∅ | Stripping length | | | | | | | | | | | | | | | | | | | | | | | | | | | | | | |
| 0.14-0.37 mm ² | AWG 26-22 | 0.9 | 8 mm | | | | | | | | | | | | | | | | | | | | | | | | | | | | | | |
| 0.5 mm ² | AWG 20 | 1.1 | 8 mm | | | | | | | | | | | | | | | | | | | | | | | | | | | | | | |
| 0.75 mm ² | AWG 18 | 1.3 | 8 mm | | | | | | | | | | | | | | | | | | | | | | | | | | | | | | |
| 1 mm ² | AWG 18 | 1.45 | 8 mm | | | | | | | | | | | | | | | | | | | | | | | | | | | | | | |
| 1.5 mm ² | AWG 16 | 1.75 | 8 mm | | | | | | | | | | | | | | | | | | | | | | | | | | | | | | |
| 2.5 mm ² | AWG 14 | 2.25 | 6 mm | | | | | | | | | | | | | | | | | | | | | | | | | | | | | | |
| gold plated | 0.14-0.37 0.5 0.75 1 1.5 2.5 | 09 15 000 6124 09 15 000 6123 09 15 000 6125 09 15 000 6122 09 15 000 6121 09 15 000 6126 | 09 15 000 6224 09 15 000 6223 09 15 000 6225 09 15 000 6222 09 15 000 6221 09 15 000 6226 | | | | | | | | | | | | | | | | | | | | | | | | | | | | | | |
| F.O. contacts for 1 mm plastic fibre | | 20 10 001 3211 | 20 10 001 3221 | | | | | | | | | | | | | | | | | | | | | | | | | | | | | | |

Stock items in bold type



Features

- Innovative Han-Quick Lock[®] termination technology
- Field assembly without special tools
- Mating compatible with standard Han[®] DD module with crimp terminal
- Reduced wiring times

Technical characteristics

| | |
|----------------|----------------------------------|
| Specifications | DIN EN 60 664-1 DIN EN 61 984 |
|----------------|----------------------------------|

Inserts

| | |
|--------------------------------------|--------------------------|
| Number of contacts | 12 |
| Electrical data acc. to EN 61 984 | 10 A 250 V 4 kV 3 |
| Rated current | 10 A |
| Rated voltage | 250 V |
| Rated impulse voltage | 4 kV |
| Pollution degree | 3 |

| | |
|--|----------------------|
| Insulation resistance | ≥ 10 ¹⁰ Ω |
| Material | polycarbonate |
| Limiting temperatures | -40 °C ... +125 °C |
| Flammability acc. to UL 94 | V 0 |
| Mechanical working life - mating cycles | |

Contacts

| | |
|------------------------|------------------------------|
| Material | copper alloy |
| Surface | |
| - hard-silver plated | 3 μm Ag |
| Contact resistance | ≤ 3 mΩ |
| Quick Lock termination | |
| - mm ² | 0.25 ... 1.5 mm ² |
| - AWG | 22 ... 16 |

Current carrying capacity

The current carrying capacity of the connectors is limited by the thermal load capability of the contact element material including the connections and the insulating parts. The derating curve is therefore valid for currents which flow constantly (non-intermittent) through each contact element of the connector evenly, without exceeding the allowed maximum temperature.

Measuring and testing techniques according to
DIN EN 60 512-5

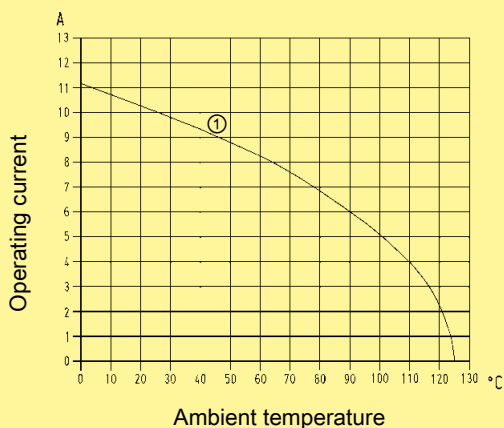



① 24 B hoods/housings with 6 modules; wire gauge: 1.5 mm²

Number of contacts

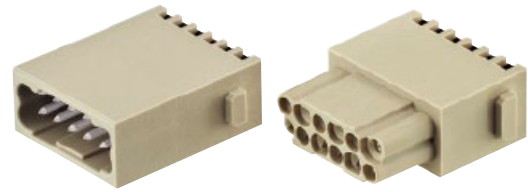
12

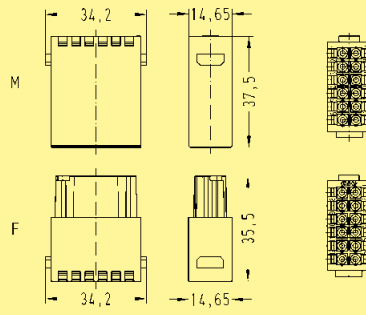

| Identification | Part number | | Drawing | Dimensions in mm |
|---|-----------------------|-----------------------|---|------------------|
| | Male insert (M) | Female insert (F) | | |
| Quick Lock termination  | 09 14 012 2632 | 09 14 012 2732 |  | |
| | | | Contact arrangement view from termination side  | |

Han Modular

06
69

Stock items in bold type

Features

- Suitable for Han D® crimp contacts
- High contact density

Technical characteristics

Specifications DIN EN 60 664-1
DIN EN 61 984

Approvals

Inserts

| | |
|--------------------------------------|----------------------------|
| Number of contacts | 17 |
| Electrical data acc. to EN 61 984 | 10 A 160 V 2.5 kV 3 |
| Rated current | 10 A |
| Rated voltage | 160 V |
| Rated impulse voltage | 2.5 kV |
| Pollution degree | 3 |

| | |
|--|----------------------|
| Rated voltage acc. to UL | 250 V |
| Insulation resistance | ≥ 10 ¹⁰ Ω |
| Material | polycarbonate |
| Limiting temperatures | -40 °C ... +125 °C |
| Flammability acc. to UL 94 | V 0 |
| Mechanical working life - mating cycles | ≥ 500 |

Contacts

| | |
|----------------------|------------------------------|
| Material | copper alloy |
| Surface | |
| - hard-silver plated | 3 μm Ag |
| - hard-gold plated | 2 μm Au over 3 μm Ni |
| Contact resistance | ≤ 3 mΩ |
| Crimp terminal | |
| - mm ² | 0.14 ... 2.5 mm ² |
| - AWG | 26 ... 14 |

Current carrying capacity

The current carrying capacity of the connectors is limited by the thermal load capability of the contact element material including the connections and the insulating parts. The derating curve is therefore valid for currents which flow constantly (non-intermittent) through each contact element of the connector evenly, without exceeding the allowed maximum temperature.

Measuring and testing techniques according to DIN EN 60 512-5

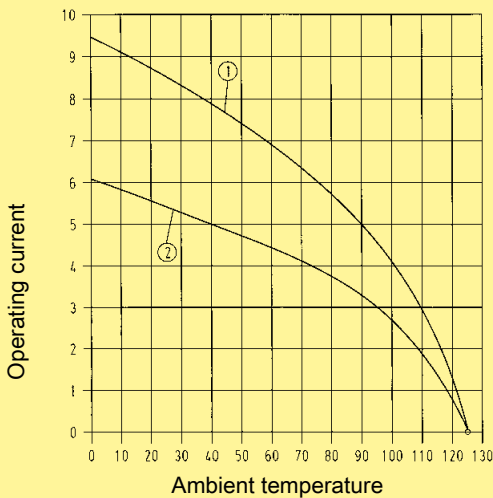

① 24 B hoods/housings with 6 modules; wire gauge: 1.5 mm²

② 24 B hoods/housings with 6 modules; wire gauge: 1.0 mm²

Number of contacts

17

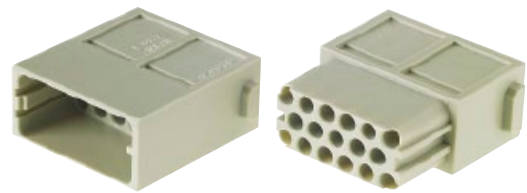

| Identification | Part number | | Drawing | Dimensions in mm |
|---|-----------------------|-----------------------|---|------------------|
| | Male insert (M) | Female insert (F) | | |
| Crimp terminal Order crimp contacts separately | 09 14 017 3001 | 09 14 017 3101 | <p>Contact arrangement view from termination side</p> | |

Han Modular

| Identification | Wire gauge (mm ²) | Part number | | Drawing | Dimensions in mm | | | | | | | | | | | | | | | | | | | | | | | | | | | | |
|---|---|--|--|--|------------------|--|---|------------------|---------------------------|-----------|-----|------|---------------------|--------|-----|------|----------------------|--------|-----|------|-------------------|--------|------|------|---------------------|--------|------|------|---------------------|--------|------|------|--|
| | | Male contact | Female contact | | | | | | | | | | | | | | | | | | | | | | | | | | | | | | |
| Crimp contacts Power contacts silver plated | 0.14-0.37 0.5 0.75 1 1.5 2.5 | 09 15 000 6104 09 15 000 6103 09 15 000 6105 09 15 000 6102 09 15 000 6101 09 15 000 6106 | 09 15 000 6204 09 15 000 6203 09 15 000 6205 09 15 000 6202 09 15 000 6201 09 15 000 6206 | <table border="1"> <thead> <tr> <th colspan="2">Wire gauge</th> <th>∅</th> <th>Stripping length</th> </tr> </thead> <tbody> <tr> <td>0.14-0.37 mm²</td> <td>AWG 26-22</td> <td>0.9</td> <td>8 mm</td> </tr> <tr> <td>0.5 mm²</td> <td>AWG 20</td> <td>1.1</td> <td>8 mm</td> </tr> <tr> <td>0.75 mm²</td> <td>AWG 18</td> <td>1.3</td> <td>8 mm</td> </tr> <tr> <td>1 mm²</td> <td>AWG 18</td> <td>1.45</td> <td>8 mm</td> </tr> <tr> <td>1.5 mm²</td> <td>AWG 16</td> <td>1.75</td> <td>8 mm</td> </tr> <tr> <td>2.5 mm²</td> <td>AWG 14</td> <td>2.25</td> <td>6 mm</td> </tr> </tbody> </table> | Wire gauge | | ∅ | Stripping length | 0.14-0.37 mm ² | AWG 26-22 | 0.9 | 8 mm | 0.5 mm ² | AWG 20 | 1.1 | 8 mm | 0.75 mm ² | AWG 18 | 1.3 | 8 mm | 1 mm ² | AWG 18 | 1.45 | 8 mm | 1.5 mm ² | AWG 16 | 1.75 | 8 mm | 2.5 mm ² | AWG 14 | 2.25 | 6 mm | |
| Wire gauge | | ∅ | Stripping length | | | | | | | | | | | | | | | | | | | | | | | | | | | | | | |
| 0.14-0.37 mm ² | AWG 26-22 | 0.9 | 8 mm | | | | | | | | | | | | | | | | | | | | | | | | | | | | | | |
| 0.5 mm ² | AWG 20 | 1.1 | 8 mm | | | | | | | | | | | | | | | | | | | | | | | | | | | | | | |
| 0.75 mm ² | AWG 18 | 1.3 | 8 mm | | | | | | | | | | | | | | | | | | | | | | | | | | | | | | |
| 1 mm ² | AWG 18 | 1.45 | 8 mm | | | | | | | | | | | | | | | | | | | | | | | | | | | | | | |
| 1.5 mm ² | AWG 16 | 1.75 | 8 mm | | | | | | | | | | | | | | | | | | | | | | | | | | | | | | |
| 2.5 mm ² | AWG 14 | 2.25 | 6 mm | | | | | | | | | | | | | | | | | | | | | | | | | | | | | | |
| F.O. contacts for 1 mm plastic fibre | | 20 10 001 3211 | 20 10 001 3221 | | | | | | | | | | | | | | | | | | | | | | | | | | | | | | |

Stock items in bold type

Features

- Suitable for D-Sub crimp contacts
- High contact density
- Using of guiding pins (male and female) is recommended (see chapter 40).

Technical characteristics

Specifications DIN EN 60 664-1
DIN EN 61 984

Approvals

Inserts

| | |
|--------------------------------------|--------------------------|
| Number of contacts | 25 |
| Electrical data acc. to EN 61 984 | 4 A 50 V 0.8 kV 3 |
| Rated current | 4 A |
| Rated voltage | 50 V |
| Rated impulse voltage | 0.8 kV |
| Pollution degree | 3 |

| | |
|--|----------------------|
| Rated voltage acc. to UL | < 30 V |
| Insulation resistance | ≥ 10 ¹⁰ Ω |
| Material | polycarbonate |
| Limiting temperatures | -40 °C ... +125 °C |
| Flammability acc. to UL 94 | V 0 |
| Mechanical working life - mating cycles | ≥ 500 |

Contacts

| | |
|-------------------|--|
| Crimp terminal | |
| - mm ² | 0.08 ... 0.52 mm ² |
| - AWG | 28 ... 20 |
| turned contacts | |
| | Performance level 1 as per CECC 75 301-802, 500 mating cycles, 10 days 4 mixed gas test - IEC 60 512 |

Current carrying capacity

The current carrying capacity of the connectors is limited by the thermal load capability of the contact element material including the connections and the insulating parts. The derating curve is therefore valid for currents which flow constantly (non-intermittent) through each contact element of the connector evenly, without exceeding the allowed maximum temperature.

Measuring and testing techniques according to
DIN EN 60 512-5

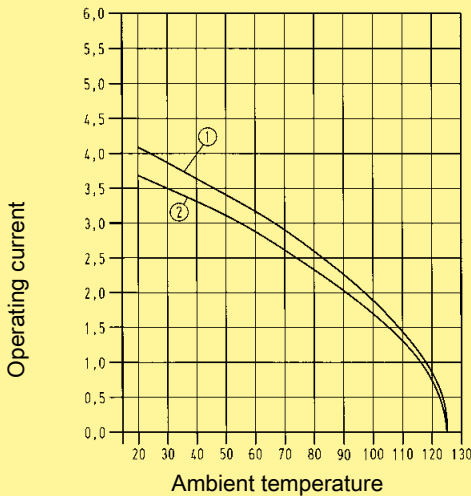

① 24 B hoods/housings with 6 modules; wire gauge: 0.5 mm² turned contacts

② 24 B hoods/housings with 6 modules; wire gauge: 0.5 mm² stamped contacts

Number of contacts

25

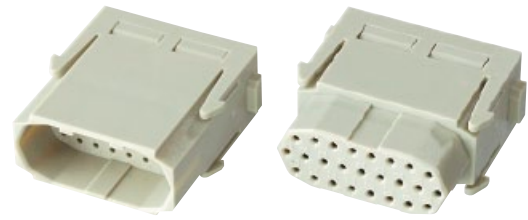

| Identification | Part number | | Drawing | Dimensions in mm |
|---|-----------------------|-----------------------|---|------------------|
| | Male insert (M) | Female insert (F) | | |
| Crimp terminal Order crimp contacts separately | 09 14 025 3001 | 09 14 025 3101 | <p style="text-align: center;">Contact arrangement view from termination side</p> | |

Han Modular

| Identification | Wire gauge (mm²) | Part number | | Drawing | Dimensions in mm | | | | | | | | | | | | |
|--|-------------------------------------|---|---|---|------------------|--|------------------|---------------|-----------|------|---------------|-----------|------|---------------|-----------|------|--|
| | | Male contact | Female contact | | | | | | | | | | | | | | |
| D-Sub crimp contacts | 0.08-0.21 0.13-0.33 0.21-0.52 | 09 67 000 7576 09 67 000 5576 09 67 000 8576 | 09 67 000 7476 09 67 000 5476 09 67 000 8476 | <table border="1"> <thead> <tr> <th colspan="2">Wire gauge</th> <th rowspan="2">Stripping length</th> </tr> </thead> <tbody> <tr> <td>0.08-0.21 mm²</td> <td>AWG 28-24</td> <td>4 mm</td> </tr> <tr> <td>0.13-0.33 mm²</td> <td>AWG 26-22</td> <td>4 mm</td> </tr> <tr> <td>0.21-0.52 mm²</td> <td>AWG 24-20</td> <td>4 mm</td> </tr> </tbody> </table> | Wire gauge | | Stripping length | 0.08-0.21 mm² | AWG 28-24 | 4 mm | 0.13-0.33 mm² | AWG 26-22 | 4 mm | 0.21-0.52 mm² | AWG 24-20 | 4 mm | |
| Wire gauge | | Stripping length | | | | | | | | | | | | | | | |
| 0.08-0.21 mm² | AWG 28-24 | | 4 mm | | | | | | | | | | | | | | |
| 0.13-0.33 mm² | AWG 26-22 | 4 mm | | | | | | | | | | | | | | | |
| 0.21-0.52 mm² | AWG 24-20 | 4 mm | | | | | | | | | | | | | | | |
| Insertion / Removal tool for D-Sub crimp contacts | | 09 99 000 0368 | 09 99 000 0368 | | | | | | | | | | | | | | |

Features

- 9-pin D-Sub connector of the Han-Modular® system
- Ideal for the transmission of sensitive signals
- Compatible to crimp, solder or IDC termination
- Using of guiding pins (male and female) is recommended (see chapter 40).

Technical characteristics

Specifications DIN EN 60 664-1
 DIN EN 61 984

Approvals 

Inserts

| | |
|--|--------------------------|
| Number of contacts | 9 |
| Electrical data acc. to EN 61 984 | 5 A 50 V 0.8 kV 3 |
| Rated current | 5 A |
| Rated voltage | 50 V |
| Rated impulse voltage | 0.8 kV |
| Pollution degree | 3 |
| Rated voltage acc. to UL | < 30 V |
| Insulation resistance | ≥ 10 ¹⁰ Ω |
| Material | polycarbonate |
| Limiting temperatures | -40 °C ... +125 °C |
| Flammability acc. to UL 94 | V 0 |
| Mechanical working life - mating cycles | ≥ 500 |

Number of contacts

9

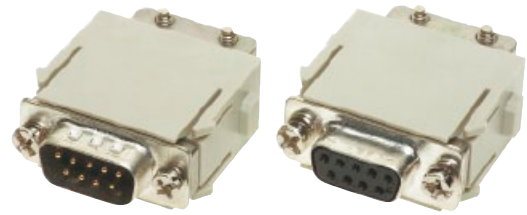

| Identification | Part number | | Drawing | Dimensions in mm | | | | | | |
|--|-----------------------|-----------------------|---|------------------|-------------|---|---|---|---|--|
| | Male insert (M) | Female insert (F) | | | | | | | | |
| <p>Crimp terminal Order crimp contacts separately (see page 06.65)</p> | 09 14 009 3001 | 09 14 009 3101 | | | | | | | | |
| <p>Adapter module without D-Sub insert</p> <p>for one cable</p> <p>for two cables</p> | 09 14 000 9930 | 09 14 000 9931 | | | | | | | | |
| <p>Screw terminal for RS 485-based bus systems with T-functionality</p> | | 09 14 009 3151 | <p>Contact arrangement view from termination side</p> <table border="1"> <thead> <tr> <th>Signal</th> <th>Contact no.</th> </tr> </thead> <tbody> <tr> <td>A</td> <td>8</td> </tr> <tr> <td>B</td> <td>3</td> </tr> </tbody> </table> | Signal | Contact no. | A | 8 | B | 3 | |
| Signal | Contact no. | | | | | | | | | |
| A | 8 | | | | | | | | | |
| B | 3 | | | | | | | | | |

Han Modular

Features

- According to USB 2.0 specification
- Simple and cost effective termination by plug in patch cable
- Cable tie strain relief

Technical characteristics

Specifications DIN EN 60 664-1
 DIN EN 61 984

Approvals 





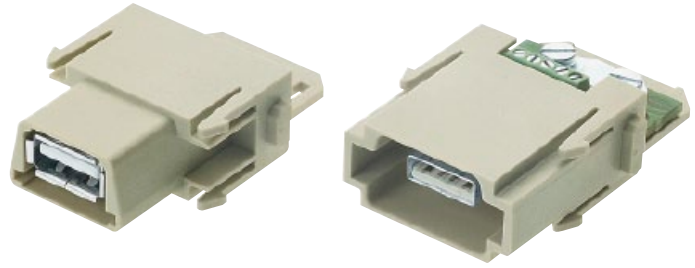

Inserts

| | |
|----------------------------|--------------------------|
| Number of contacts | 4 |
| Electrical data | |
| acc. to EN 61 984 | 1 A 50 V 0.8 kV 3 |
| Rated current | 1 A |
| Rated voltage | 50 V |
| Rated impulse voltage | 0.8 kV |
| Pollution degree | 3 |
| Rated voltage | |
| acc. to UL | < 30 V |
| Insulation resistance | ≥ 10 ¹⁰ Ω |
| Material | polycarbonate |
| Limiting temperatures | -40 °C ... +85 °C |
| Flammability acc. to UL 94 | V 0 |
| Mechanical working life | |
| - mating cycles | ≥ 500 |

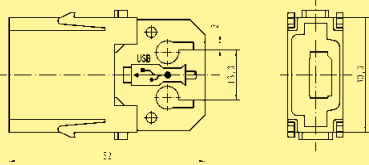
Number of contacts

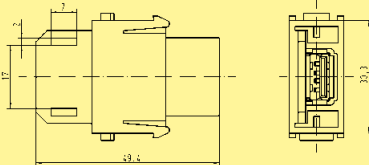
4

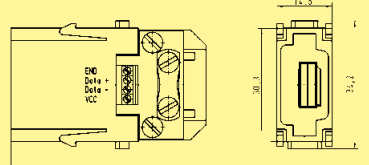

| Identification | Part number | | Drawing | Dimensions in mm |
|--|--|--|--|------------------|
| | Male insert (M) | Female insert (F) | | |
| Module for patch cable Male insert  | 09 14 001 4601 | |  | |
| Module for patch cable Female insert  | | 09 14 001 4701 |  | |
| Module for screw termination Male insert  | 09 14 001 4651 | |  | |
| Patch cable USB male / male Style A  | 2 m 39 50 903 0050 5 m 39 50 903 0051 | 2 m 39 50 903 0050 5 m 39 50 903 0051 | | |

Han
Modular

Features

- Compatible to IEEE 1394
- Simple and cost effective termination by plug in patch cable
- Cable tie strain relief

Technical characteristics

Specifications DIN EN 60 664-1
 DIN EN 61 984

Approvals 



Inserts

| | |
|--|--------------------------|
| Number of contacts | 6 |
| Electrical data acc. to EN 61 984 | 1 A 50 V 0.8 kV 3 |
| Rated current | 1 A |
| Rated voltage | 50 V |
| Rated impulse voltage | 0.8 kV |
| Pollution degree | 3 |
| Rated voltage acc. to UL | < 30 V |
| Insulation resistance | ≥ 10 ¹⁰ Ω |
| Material | polycarbonate |
| Limiting temperatures | -40 °C ... +85 °C |
| Flammability acc. to UL 94 | V 0 |
| Mechanical working life - mating cycles | ≥ 500 |

Number of contacts

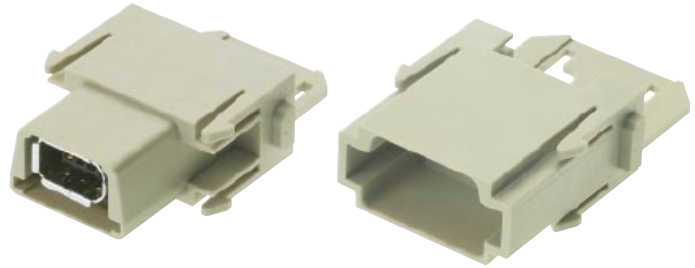
6

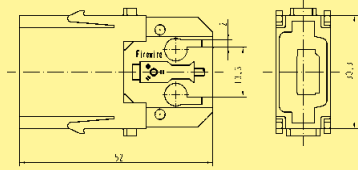

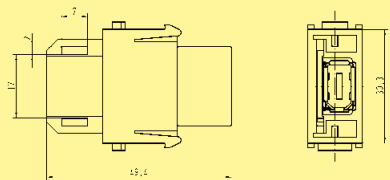
| Identification | Part number | | Drawing | Dimensions in mm |
|--|-----------------------|-----------------------|---|------------------|
| | Male insert (M) | Female insert (F) | | |
| Module for patch cable Male insert  | 09 14 001 4611 | |  | |
| Module for patch cable Female insert  | | 09 14 001 4711 |  | |

Han
Modular

Features

- Single module with standard shielded RJ45 plug and jack
- Cat 6 for all data pairs (all 8 pins)
- Conforming to the RoHS directive
- The RJ45 inserts are protected by a reliable plastic insulator
- Patch cables are assembled/removed without tools

Technical characteristics

Specifications DIN EN 60 664-1
DIN EN 61 984

Approvals 





Inserts

| | |
|--|--|
| Number of contacts | 8 |
| Electrical data acc. to EN 61 984 | 1 A 50 V 0.8 kV 3 |
| Rated current | 1 A |
| Rated voltage | 50 V |
| Rated impulse voltage | 0.8 kV |
| Pollution degree | 3 |
| Rated voltage acc. to UL | < 30 V |
| Transmission features | Category 6 / Class E up to 250 MHz; acc. to ISO/IEC 11 801:2002 and EN 50 173-1 |
| Transmission rate | 10/100/1000 Mbit/s |
| Insulation resistance | ≥ 10 ¹⁰ Ω |
| Material | polycarbonate |
| Limiting temperatures | -40 °C ... +85 °C |
| Flammability acc. to UL 94 | V 0 |
| Mechanical working life - mating cycles | ≥ 500 |

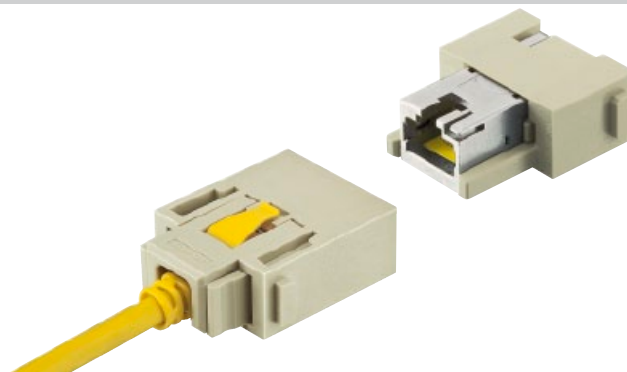
Number of contacts

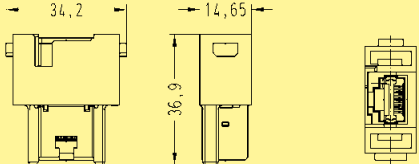
8

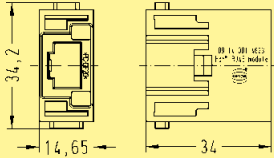

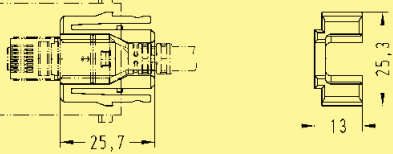
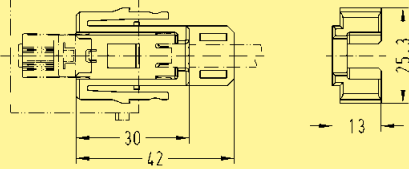
| Identification | Part number | | Drawing | Dimensions in mm |
|---|-----------------------|-----------------------|--|------------------|
| | Male insert (M) | Female insert (F) | | |
| Gender Changer for patch cable  | | 09 14 001 4721 |  | |
| Male insert  | 09 14 001 4623 | |  | |
| Adapter for HARTING patch cable  | 09 14 000 9966 | |  | |
| Adapter for HARTING RJ Industrial® see page 06.85 | | |  | |

Han
Modular

Features

- Locking lever protection for RJ45 connector latch
- Very short plug design in combination with robust bend protection
- RoHS compliant
- Fully EMC screened (aluminium-clad foil and braid)

Technical characteristics

| | |
|----------------|--|
| Specifications | ISO/IEC 24 702 ISO/IEC 11 801 ISO/IEC 61 935-2 |
|----------------|--|

Cat. 5 e RJ45 patch cable

| | |
|-----------------------|---|
| Transmission features | Category 5 / Class D up to 100 MHz; acc. to ISO/IEC 24 702 or ISO/IEC 11 801 |
| Transmission rate | 10/100/1000 Mbit/s |
| Cable type | 1:1 EIA/TIA 568 B, 8 poles |
| Material cables | SF/UTP, PUR, yellow |
| Limiting temperatures | |
| - mobile | 0 °C ... +60 °C |
| - stationary | -40 °C ... +80 °C |
| Flammability | flame retardant, halogen-free |
| Degree of protection | IP 20 |

Cat. 6 RJ45 patch cable

| | |
|-----------------------|---|
| Transmission features | Category 6 / Class E up to 250 MHz; acc. to ISO/IEC 24 702 or ISO/IEC 11 801 |
| Transmission rate | 10/100/1000 Mbit/s |
| Cable type | 1:1 EIA/TIA 568 B, 8 poles |
| Material cables | SF/UTP, PUR, yellow |
| Limiting temperatures | |
| - mobile | 0 °C ... +60 °C |
| - stationary | -20 °C ... +80 °C |
| Flammability | flame retardant, halogen-free |
| Degree of protection | IP 20 |

Number of contacts

8



Identification

Part number

Drawing

Dimensions in mm

Cat. 5e RJ45 patch cable

| Length | Part number |
|--------|-----------------------|
| 0.2 m | 09 47 474 7001 |
| 0.3 m | 09 47 474 7002 |
| 0.4 m | 09 47 474 7003 |
| 0.5 m | 09 47 474 7004 |
| 0.6 m | 09 47 474 7005 |
| 0.7 m | 09 47 474 7006 |
| 0.8 m | 09 47 474 7007 |
| 0.9 m | 09 47 474 7008 |
| 1.0 m | 09 47 474 7009 |
| 1.5 m | 09 47 474 7010 |
| 2.0 m | 09 47 474 7011 |
| 2.5 m | 09 47 474 7012 |
| 3.0 m | 09 47 474 7013 |
| 4.0 m | 09 47 474 7014 |
| 5.0 m | 09 47 474 7015 |
| 6.0 m | 09 47 474 7016 |
| 7.0 m | 09 47 474 7017 |
| 7.5 m | 09 47 474 7018 |
| 8.0 m | 09 47 474 7019 |
| 9.0 m | 09 47 474 7020 |
| 10 m | 09 47 474 7021 |
| 15 m | 09 47 474 7022 |
| 20 m | 09 47 474 7023 |

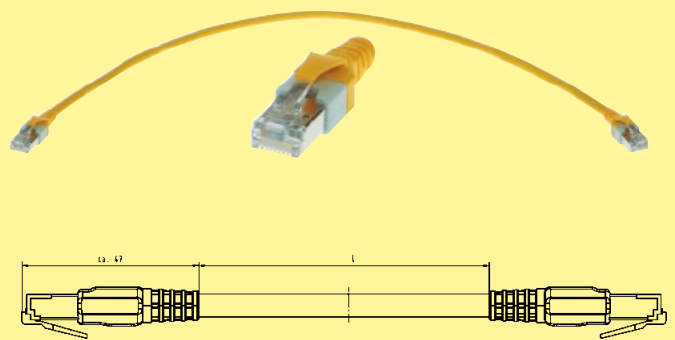

Han Modular

Cat. 6 RJ45 patch cable

| Length | Part number |
|--------|-----------------------|
| 0.2 m | 09 47 474 7101 |
| 0.3 m | 09 47 474 7102 |
| 0.4 m | 09 47 474 7103 |
| 0.5 m | 09 47 474 7104 |
| 0.6 m | 09 47 474 7105 |
| 0.7 m | 09 47 474 7106 |
| 0.8 m | 09 47 474 7107 |
| 0.9 m | 09 47 474 7108 |
| 1.0 m | 09 47 474 7109 |
| 1.5 m | 09 47 474 7110 |
| 2.0 m | 09 47 474 7111 |
| 2.5 m | 09 47 474 7112 |
| 3.0 m | 09 47 474 7113 |
| 4.0 m | 09 47 474 7114 |
| 5.0 m | 09 47 474 7115 |
| 6.0 m | 09 47 474 7116 |
| 7.0 m | 09 47 474 7117 |
| 7.5 m | 09 47 474 7118 |
| 8.0 m | 09 47 474 7119 |
| 9.0 m | 09 47 474 7120 |
| 10 m | 09 47 474 7121 |
| 15 m | 09 47 474 7122 |
| 20 m | 09 47 474 7123 |

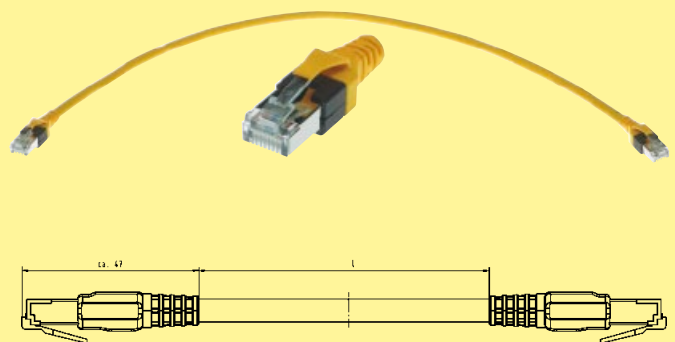

Features

Han-Modular® RJ Industrial RJ45 connector set

- Conforming to the RoHS directive
- 360° shielded contact
- Field assembly without tools possible by means of HARAX® rapid termination in IDC technology
- Suitable for termination of massive and flexible wires

Han-Modular® RJ Industrial Gigalink RJ45 connector set

- Conforming to the RoHS directive
- 360° shielded contact
- Field assembly by means of piercing contacts
- Suitable for termination of flexible wires

Technical characteristics

| | |
|----------------|--|
| Specifications | IEC 60 603-7 DIN EN 60 664-1 DIN EN 61 984 |
|----------------|--|

HARTING RJ Industrial®, 4 pins

| | |
|---------------------------|--|
| Number of contacts | 4 |
| Transmission features | Category 5 / Class D up to 100 MHz; acc. to ISO/IEC 11 801:2002 and EN 50 173-1 |
| Transmission rate | 10/100 Mbit/s |
| Wire termination | IDC contacts; without tools |
| Terminated cable | |
| - Conductor cross section | |
| flexible | AWG 24/7 ... AWG 22/7 |
| solid | AWG 23/1 ... AWG 22/1 |
| - Cable outside diameter | ≤ 1.6 mm |
| Material insert | polyamide |
| Limiting temperatures | -40 °C ... +70 °C |

HARTING RJ Industrial® Gigalink, 8 pins

| | |
|---------------------------|--|
| Number of contacts | 8 |
| Transmission features | Category 6 / Class E up to 250 MHz; acc. to ISO/IEC 11 801:2002 and EN 50 173-1 |
| Transmission rate | 10/100/1000 Mbit/s |
| Wire termination | Piercing contacts |
| Terminated cable | |
| - Conductor cross section | |
| flexible | AWG 28/7 ... AWG 24/7 |
| - Cable outside diameter | ≤ 1.05 mm |
| Material insert | polyamide |
| Limiting temperatures | -40 °C ... +70 °C |

HARTING RJ Industrial® 10G, 8 pins

| | |
|---------------------------|--|
| Number of contacts | 8 |
| Transmission features | Category 6 / Class E up to 250 MHz; acc. to ISO/IEC 11 801:2002 and EN 50 173-1 |
| Transmission rate | 10/100/1000 Mbit/s |
| Wire termination | IDC contacts; without tools |
| Terminated cable | |
| - Conductor cross section | |
| flexible | AWG 27/7 ... AWG 22/7 |
| solid | AWG 27/1 ... AWG 22/1 |
| - Cable outside diameter | ≤ 1.5 mm |
| Material insert | polyamide |
| Limiting temperatures | -40 °C ... +70 °C |

Number of contacts

4 / 8

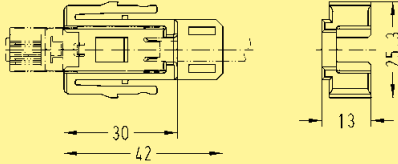

| Identification | Part number Male insert (M) | Drawing | Dimensions in mm |
|---|--|--|---|
| <p>Han-Modular® RJ Industrial RJ45 connector set</p>  <p>Cat. 5 4 pins for AWG 24 ... 22 4 pins for AWG 26</p> <p>Cat. 6 Gigalink, 8 pins Gigalink, 8 pins</p> <p>Cat. 6 10G, 8 pins</p> | <p>09 45 400 1100 09 45 400 1109</p> <p>09 45 400 1500 09 45 400 1510</p> <p>09 45 400 1560</p> |  | <p>Set consists of the relevant RJ45 insert and the suitable adapter for Han® RJ45 male module (please order the male module 09 14 001 4623 separately)</p> |

| | | | |
|--|------------------------------|--|--|
| <p>HARTING RJ Industrial® Gigalink Assembly tool</p> | <p>09 45 800 0500</p> |  | |
|--|------------------------------|--|--|

* usable with male insert 09 14 001 4623 (see page 06.81)

Features

- Shielding bus separate from housing potential
- Ideal for the transmission of sensitive signals (e.g. bus signals)
- Usable for Gigabit Ethernet Cat. 6

Technical characteristics

Specifications DIN EN 60 664-1
DIN EN 61 984

Approvals 

Inserts

| | |
|----------------------------|-----------------------|
| Number of contacts | 8 |
| Insulation resistance | $\geq 10^{10} \Omega$ |
| Material | polycarbonate |
| Limiting temperatures | -40 °C ... +125 °C |
| Flammability acc. to UL 94 | V 0 |
| Mechanical working life | |
| - mating cycles | ≥ 500 |

GigaBit contacts

| | |
|-----------------------|--------------------------|
| Number of contacts | 8 + shielding |
| Electrical data | |
| acc. to EN 61 984 | 5 A 50 V 0.8 kV 3 |
| Rated current | 5 A |
| Rated voltage | 50 V |
| Rated impulse voltage | 0.8 kV |
| Pollution degree | 3 |
| Rated voltage | |
| acc. to UL | < 30 V |

| | |
|----------------------------|--------------------------|
| Material | |
| - Insulator | polycarbonate |
| - Outer conductor | zinc alloy |
| Contact resistance | $\leq 4 \text{ m}\Omega$ |
| Limiting temperatures | -40 °C ... +85 °C |
| Flammability acc. to UL 94 | V 0 |
| Outer surface finish | nickel |
| Cable diameter | 5 ... 12 mm |

D-Sub crimp contacts

| | |
|-------------------|-------------------------------|
| Crimp terminal | |
| - mm ² | 0.08 ... 0.52 mm ² |
| - AWG | 28 ... 20 |
| turned contacts | Performance level 1 |

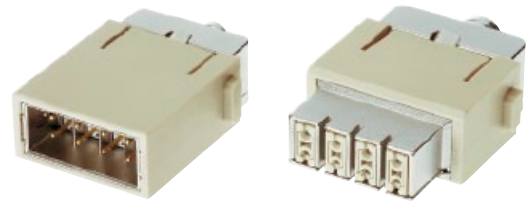

Number of contacts

8

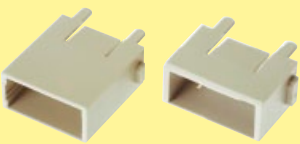
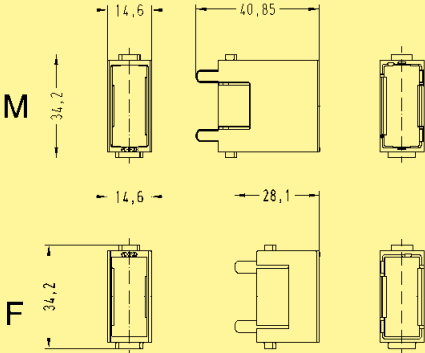

| Identification | Part number | | Drawing | Dimensions in mm |
|--|-----------------------|-----------------------|--|------------------|
| | Male insert (M) | Female insert (F) | | |
| Han® GigaBit module  | 09 14 001 3011 | 09 14 001 3111 |  | |

Han Modular

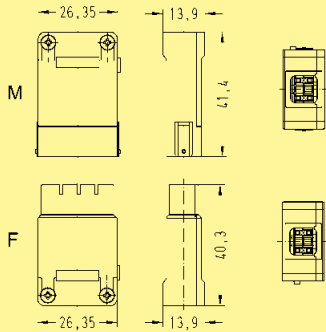
| Identification | Wire gauge (mm²) | Part number | | Drawing | Dimensions in mm | | | | | | | | | | | | |
|--|-------------------------------------|---|---|--|---|------------|--|------------------|---------------|-----------|------|---------------|-----------|------|---------------|-----------|------|
| | | Male contact | Female contact | | | | | | | | | | | | | | |
| GigaBit contacts 8 + shielding Order crimp contacts separately  D-Sub crimp contacts  | 0,08-0,21 0,13-0,33 0,21-0,52 | 09 14 008 3011 09 67 000 7576 09 67 000 5576 09 67 000 8576 | 09 14 008 3111 09 67 000 7476 09 67 000 5476 09 67 000 8476 |  | <table border="1"> <thead> <tr> <th colspan="2">Wire gauge</th> <th>Stripping length</th> </tr> </thead> <tbody> <tr> <td>0,08-0,21 mm²</td> <td>AWG 28-24</td> <td>4 mm</td> </tr> <tr> <td>0,13-0,33 mm²</td> <td>AWG 26-22</td> <td>4 mm</td> </tr> <tr> <td>0,21-0,52 mm²</td> <td>AWG 24-20</td> <td>4 mm</td> </tr> </tbody> </table> | Wire gauge | | Stripping length | 0,08-0,21 mm² | AWG 28-24 | 4 mm | 0,13-0,33 mm² | AWG 26-22 | 4 mm | 0,21-0,52 mm² | AWG 24-20 | 4 mm |
| Wire gauge | | Stripping length | | | | | | | | | | | | | | | |
| 0,08-0,21 mm² | AWG 28-24 | 4 mm | | | | | | | | | | | | | | | |
| 0,13-0,33 mm² | AWG 26-22 | 4 mm | | | | | | | | | | | | | | | |
| 0,21-0,52 mm² | AWG 24-20 | 4 mm | | | | | | | | | | | | | | | |

06
87

Stock items in bold type

Han
Modular

| Identification | Part number | Drawing | Dimensions in mm | | | | | | | | | | | | | | | | | | | | | | | | | | | | | | | | | | | | | | | | | | | | | | | | | | | | | | |
|---|--|-----------------------|------------------|-----|-----|-----------------------|-----|-----|-----------------------|-----|-----|-----------------------|-----|-----|----------------|-----|-----|-----------------------|-----|-----|-----------------------|-----|-----|-----------------------|-----|-----|-----------------------|-----|------|-----------------------|-----|------|-----------------------|------|------|-----------------------|------|------|----------------|------|------|-----------------------|------|------|-----------------------|------|------|----------------|------|------|----------------|------|------|----------------|--|--|--|
| <p>Crimp flange</p> <table border="0" style="width: 100%;"> <tr> <td style="text-align: right;">D1</td> <td style="text-align: left;">D2</td> <td></td> </tr> <tr> <td style="text-align: right;">3.0</td> <td style="text-align: left;">4.0</td> <td>61 03 000 0062</td> </tr> <tr> <td style="text-align: right;">3.5</td> <td style="text-align: left;">4.5</td> <td>61 03 000 0063</td> </tr> <tr> <td style="text-align: right;">4.0</td> <td style="text-align: left;">5.0</td> <td>61 03 000 0064</td> </tr> <tr> <td style="text-align: right;">4.5</td> <td style="text-align: left;">5.5</td> <td>61 03 000 0065</td> </tr> <tr> <td style="text-align: right;">5.0</td> <td style="text-align: left;">6.0</td> <td>61 03 000 0066</td> </tr> <tr> <td style="text-align: right;">5.5</td> <td style="text-align: left;">6.5</td> <td>61 03 000 0166</td> </tr> <tr> <td style="text-align: right;">6.0</td> <td style="text-align: left;">7.0</td> <td>61 03 000 0067</td> </tr> <tr> <td style="text-align: right;">6.5</td> <td style="text-align: left;">7.5</td> <td>61 03 000 0068</td> </tr> <tr> <td style="text-align: right;">7.0</td> <td style="text-align: left;">8.0</td> <td>61 03 000 0069</td> </tr> <tr> <td style="text-align: right;">7.5</td> <td style="text-align: left;">8.5</td> <td>61 03 000 0070</td> </tr> <tr> <td style="text-align: right;">8.0</td> <td style="text-align: left;">9.0</td> <td>61 03 000 0071</td> </tr> <tr> <td style="text-align: right;">8.5</td> <td style="text-align: left;">9.5</td> <td>61 03 000 0165</td> </tr> <tr> <td style="text-align: right;">9.0</td> <td style="text-align: left;">10.0</td> <td>61 03 000 0072</td> </tr> </table> | D1 | D2 | | 3.0 | 4.0 | 61 03 000 0062 | 3.5 | 4.5 | 61 03 000 0063 | 4.0 | 5.0 | 61 03 000 0064 | 4.5 | 5.5 | 61 03 000 0065 | 5.0 | 6.0 | 61 03 000 0066 | 5.5 | 6.5 | 61 03 000 0166 | 6.0 | 7.0 | 61 03 000 0067 | 6.5 | 7.5 | 61 03 000 0068 | 7.0 | 8.0 | 61 03 000 0069 | 7.5 | 8.5 | 61 03 000 0070 | 8.0 | 9.0 | 61 03 000 0071 | 8.5 | 9.5 | 61 03 000 0165 | 9.0 | 10.0 | 61 03 000 0072 | | | | | | | | | | | | | | | |
| D1 | D2 | | | | | | | | | | | | | | | | | | | | | | | | | | | | | | | | | | | | | | | | | | | | | | | | | | | | | | | | |
| 3.0 | 4.0 | 61 03 000 0062 | | | | | | | | | | | | | | | | | | | | | | | | | | | | | | | | | | | | | | | | | | | | | | | | | | | | | | | |
| 3.5 | 4.5 | 61 03 000 0063 | | | | | | | | | | | | | | | | | | | | | | | | | | | | | | | | | | | | | | | | | | | | | | | | | | | | | | | |
| 4.0 | 5.0 | 61 03 000 0064 | | | | | | | | | | | | | | | | | | | | | | | | | | | | | | | | | | | | | | | | | | | | | | | | | | | | | | | |
| 4.5 | 5.5 | 61 03 000 0065 | | | | | | | | | | | | | | | | | | | | | | | | | | | | | | | | | | | | | | | | | | | | | | | | | | | | | | | |
| 5.0 | 6.0 | 61 03 000 0066 | | | | | | | | | | | | | | | | | | | | | | | | | | | | | | | | | | | | | | | | | | | | | | | | | | | | | | | |
| 5.5 | 6.5 | 61 03 000 0166 | | | | | | | | | | | | | | | | | | | | | | | | | | | | | | | | | | | | | | | | | | | | | | | | | | | | | | | |
| 6.0 | 7.0 | 61 03 000 0067 | | | | | | | | | | | | | | | | | | | | | | | | | | | | | | | | | | | | | | | | | | | | | | | | | | | | | | | |
| 6.5 | 7.5 | 61 03 000 0068 | | | | | | | | | | | | | | | | | | | | | | | | | | | | | | | | | | | | | | | | | | | | | | | | | | | | | | | |
| 7.0 | 8.0 | 61 03 000 0069 | | | | | | | | | | | | | | | | | | | | | | | | | | | | | | | | | | | | | | | | | | | | | | | | | | | | | | | |
| 7.5 | 8.5 | 61 03 000 0070 | | | | | | | | | | | | | | | | | | | | | | | | | | | | | | | | | | | | | | | | | | | | | | | | | | | | | | | |
| 8.0 | 9.0 | 61 03 000 0071 | | | | | | | | | | | | | | | | | | | | | | | | | | | | | | | | | | | | | | | | | | | | | | | | | | | | | | | |
| 8.5 | 9.5 | 61 03 000 0165 | | | | | | | | | | | | | | | | | | | | | | | | | | | | | | | | | | | | | | | | | | | | | | | | | | | | | | | |
| 9.0 | 10.0 | 61 03 000 0072 | | | | | | | | | | | | | | | | | | | | | | | | | | | | | | | | | | | | | | | | | | | | | | | | | | | | | | | |
| <p>Crimp ferrule</p> <table border="0" style="width: 100%;"> <tr> <td style="text-align: right;">D3</td> <td style="text-align: left;">D4</td> <td></td> </tr> <tr> <td style="text-align: right;">5.0</td> <td style="text-align: left;">6.0</td> <td>61 03 000 0045</td> </tr> <tr> <td style="text-align: right;">5.5</td> <td style="text-align: left;">6.5</td> <td>61 03 000 0046</td> </tr> <tr> <td style="text-align: right;">6.0</td> <td style="text-align: left;">7.0</td> <td>61 03 000 0047</td> </tr> <tr> <td style="text-align: right;">6.5</td> <td style="text-align: left;">7.5</td> <td>61 03 000 0048</td> </tr> <tr> <td style="text-align: right;">7.0</td> <td style="text-align: left;">8.0</td> <td>61 03 000 0049</td> </tr> <tr> <td style="text-align: right;">7.5</td> <td style="text-align: left;">8.5</td> <td>61 03 000 0050</td> </tr> <tr> <td style="text-align: right;">8.0</td> <td style="text-align: left;">9.0</td> <td>61 03 000 0051</td> </tr> <tr> <td style="text-align: right;">8.5</td> <td style="text-align: left;">9.5</td> <td>61 03 000 0052</td> </tr> <tr> <td style="text-align: right;">9.0</td> <td style="text-align: left;">10.0</td> <td>61 03 000 0053</td> </tr> <tr> <td style="text-align: right;">9.5</td> <td style="text-align: left;">10.5</td> <td>61 03 000 0054</td> </tr> <tr> <td style="text-align: right;">10.0</td> <td style="text-align: left;">11.0</td> <td>61 03 000 0055</td> </tr> <tr> <td style="text-align: right;">10.5</td> <td style="text-align: left;">11.5</td> <td>61 03 000 0056</td> </tr> <tr> <td style="text-align: right;">11.0</td> <td style="text-align: left;">12.0</td> <td>61 03 000 0057</td> </tr> <tr> <td style="text-align: right;">11.5</td> <td style="text-align: left;">12.5</td> <td>61 03 000 0058</td> </tr> <tr> <td style="text-align: right;">12.0</td> <td style="text-align: left;">13.0</td> <td>61 03 000 0142</td> </tr> <tr> <td style="text-align: right;">12.5</td> <td style="text-align: left;">13.5</td> <td>61 03 000 0059</td> </tr> <tr> <td style="text-align: right;">13.0</td> <td style="text-align: left;">14.0</td> <td>61 03 000 0127</td> </tr> </table> | D3 | D4 | | 5.0 | 6.0 | 61 03 000 0045 | 5.5 | 6.5 | 61 03 000 0046 | 6.0 | 7.0 | 61 03 000 0047 | 6.5 | 7.5 | 61 03 000 0048 | 7.0 | 8.0 | 61 03 000 0049 | 7.5 | 8.5 | 61 03 000 0050 | 8.0 | 9.0 | 61 03 000 0051 | 8.5 | 9.5 | 61 03 000 0052 | 9.0 | 10.0 | 61 03 000 0053 | 9.5 | 10.5 | 61 03 000 0054 | 10.0 | 11.0 | 61 03 000 0055 | 10.5 | 11.5 | 61 03 000 0056 | 11.0 | 12.0 | 61 03 000 0057 | 11.5 | 12.5 | 61 03 000 0058 | 12.0 | 13.0 | 61 03 000 0142 | 12.5 | 13.5 | 61 03 000 0059 | 13.0 | 14.0 | 61 03 000 0127 | | | |
| D3 | D4 | | | | | | | | | | | | | | | | | | | | | | | | | | | | | | | | | | | | | | | | | | | | | | | | | | | | | | | | |
| 5.0 | 6.0 | 61 03 000 0045 | | | | | | | | | | | | | | | | | | | | | | | | | | | | | | | | | | | | | | | | | | | | | | | | | | | | | | | |
| 5.5 | 6.5 | 61 03 000 0046 | | | | | | | | | | | | | | | | | | | | | | | | | | | | | | | | | | | | | | | | | | | | | | | | | | | | | | | |
| 6.0 | 7.0 | 61 03 000 0047 | | | | | | | | | | | | | | | | | | | | | | | | | | | | | | | | | | | | | | | | | | | | | | | | | | | | | | | |
| 6.5 | 7.5 | 61 03 000 0048 | | | | | | | | | | | | | | | | | | | | | | | | | | | | | | | | | | | | | | | | | | | | | | | | | | | | | | | |
| 7.0 | 8.0 | 61 03 000 0049 | | | | | | | | | | | | | | | | | | | | | | | | | | | | | | | | | | | | | | | | | | | | | | | | | | | | | | | |
| 7.5 | 8.5 | 61 03 000 0050 | | | | | | | | | | | | | | | | | | | | | | | | | | | | | | | | | | | | | | | | | | | | | | | | | | | | | | | |
| 8.0 | 9.0 | 61 03 000 0051 | | | | | | | | | | | | | | | | | | | | | | | | | | | | | | | | | | | | | | | | | | | | | | | | | | | | | | | |
| 8.5 | 9.5 | 61 03 000 0052 | | | | | | | | | | | | | | | | | | | | | | | | | | | | | | | | | | | | | | | | | | | | | | | | | | | | | | | |
| 9.0 | 10.0 | 61 03 000 0053 | | | | | | | | | | | | | | | | | | | | | | | | | | | | | | | | | | | | | | | | | | | | | | | | | | | | | | | |
| 9.5 | 10.5 | 61 03 000 0054 | | | | | | | | | | | | | | | | | | | | | | | | | | | | | | | | | | | | | | | | | | | | | | | | | | | | | | | |
| 10.0 | 11.0 | 61 03 000 0055 | | | | | | | | | | | | | | | | | | | | | | | | | | | | | | | | | | | | | | | | | | | | | | | | | | | | | | | |
| 10.5 | 11.5 | 61 03 000 0056 | | | | | | | | | | | | | | | | | | | | | | | | | | | | | | | | | | | | | | | | | | | | | | | | | | | | | | | |
| 11.0 | 12.0 | 61 03 000 0057 | | | | | | | | | | | | | | | | | | | | | | | | | | | | | | | | | | | | | | | | | | | | | | | | | | | | | | | |
| 11.5 | 12.5 | 61 03 000 0058 | | | | | | | | | | | | | | | | | | | | | | | | | | | | | | | | | | | | | | | | | | | | | | | | | | | | | | | |
| 12.0 | 13.0 | 61 03 000 0142 | | | | | | | | | | | | | | | | | | | | | | | | | | | | | | | | | | | | | | | | | | | | | | | | | | | | | | | |
| 12.5 | 13.5 | 61 03 000 0059 | | | | | | | | | | | | | | | | | | | | | | | | | | | | | | | | | | | | | | | | | | | | | | | | | | | | | | | |
| 13.0 | 14.0 | 61 03 000 0127 | | | | | | | | | | | | | | | | | | | | | | | | | | | | | | | | | | | | | | | | | | | | | | | | | | | | | | | |
| <p>Cable clamp</p> <p style="margin-left: 40px;"> cable diameter approx. 5 ... 7 mm cable diameter approx. 7 ... 10 mm cable diameter approx. 10 ... 12 mm </p> | <p>61 03 000 0141 61 03 000 0044 61 03 000 0143</p> | | | | | | | | | | | | | | | | | | | | | | | | | | | | | | | | | | | | | | | | | | | | | | | | | | | | | | | | |

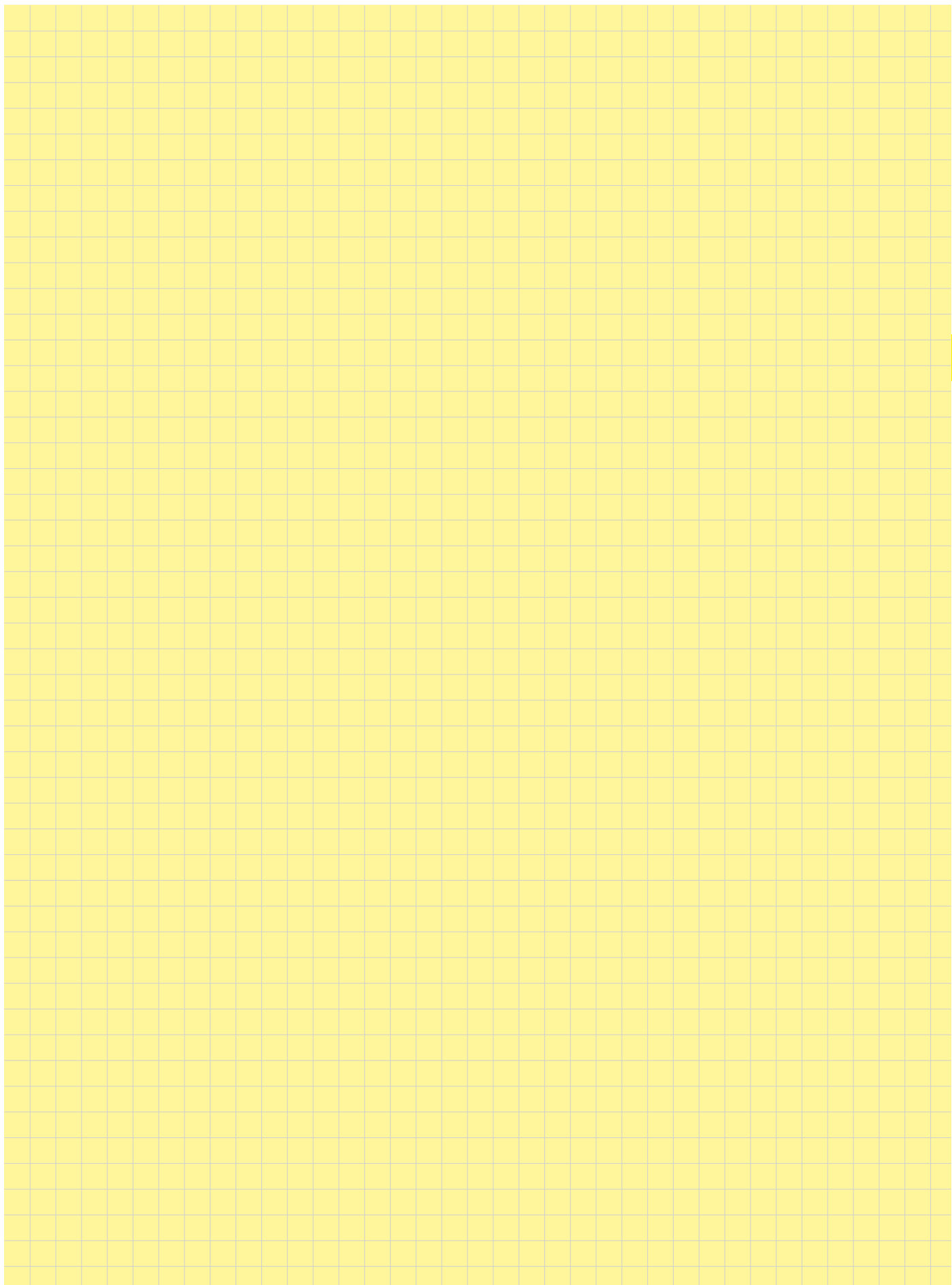

Features

- Shielding bus separate from housing potential
- Perfect for transmission of sensitive signals (eg. bus signals)
- The four pole Han® Quintax contact is suitable for Ethernet Cat. 5e and PROFIBUS when diagonally wiring of the data pairs.

Technical characteristics

Specifications DIN EN 60 664-1
DIN EN 61 984

Approvals 

Inserts

Number of contacts 2

Insulation resistance $\geq 10^{10} \Omega$
Material polycarbonate
Limiting temperatures $-40\text{ °C} \dots +125\text{ °C}$
Flammability acc. to UL 94 V 0
Mechanical working life
- mating cycles ≥ 500

Quintax contacts

Number of contacts
- Quintax 4 + shielding
- High Density Quintax 8 + shielding

Electrical data
acc. to EN 61 984
- Quintax **10 A 50 V 0.8 kV 3**
- High Density Quintax **5 A 50 V 0.8 kV 3**
Rated current 10 A / 5 A
Rated voltage 50 V
Rated impulse voltage 0.8 kV
Pollution degree 3

Material
- Insulator polycarbonate
- Outer conductor zinc alloy
Contact resistance $\leq 4\text{ m}\Omega$
Limiting temperatures $-40\text{ °C} \dots +85\text{ °C}$
Flammability acc. to UL 94 V 0
Outer surface finish nickel
Cable diameter 3 ... 9.5 mm

Han D® contacts

Material copper alloy
Surface
- hard-gold plated $2\text{ }\mu\text{m Au over }3\text{ }\mu\text{m Ni}$
Contact resistance $\leq 3\text{ m}\Omega$
Crimp terminal
- mm^2 0.14 ... 2.5 mm^2
- AWG 26 ... 14

D-Sub crimp contacts

Crimp terminal
- mm^2 0.08 ... 0.52 mm^2
- AWG 28 ... 20
turned contacts Performance level 1

Number of contacts

2

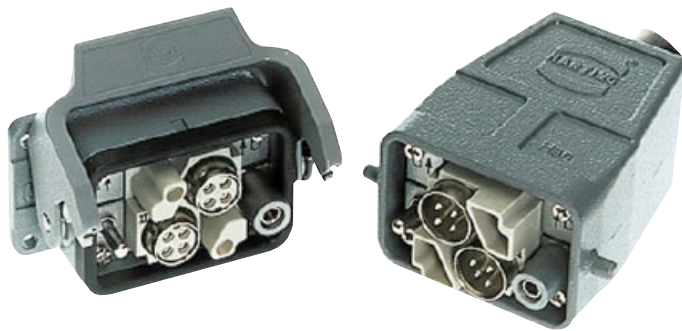

| Identification | Part number | | Drawing | Dimensions in mm |
|-------------------------------------|-----------------------|-----------------------|---|------------------|
| | Male insert (M) | Female insert (F) | | |
| <p>Crimp terminal</p> | 09 14 002 3001 | 09 14 002 3101 | <p>M</p> <p>F</p> <p>Contact arrangement view from termination side</p> | |
| <p>Quintax metal adapter option</p> | 09 14 000 9915 | 09 14 000 9915 | | |

Han Modular

| Identification | Wire gauge (mm ²) | Part number | | Drawing | Dimensions in mm | | | | | | | | | | | | |
|---|---|--|--|--|------------------|--|------------------|---------------------------|-----------|------|---------------------------|-----------|------|---------------------------|-----------|------|--|
| | | Male contact | Female contact | | | | | | | | | | | | | | |
| <p>Quintax contact 4 + shielding Han D® crimp contacts</p> | | 09 15 004 3013 | 09 15 004 3113 | | | | | | | | | | | | | | |
| <p>Han D® Crimp contact gold plated</p> | 0.14-0.37 0.5 0.75 1 1.5 2.5 | 09 15 000 6124 09 15 000 6123 09 15 000 6125 09 15 000 6122 09 15 000 6121 09 15 000 6126 | 09 15 000 6224 09 15 000 6223 09 15 000 6225 09 15 000 6222 09 15 000 6221 09 15 000 6226 | | | | | | | | | | | | | | |
| <p>High Density Quintax contact 8 + shielding Han® D-Sub contacts</p> | | 09 15 008 3013 | 09 15 008 3113 | | | | | | | | | | | | | | |
| <p>D-Sub crimp contact</p> | 0.08-0.21 0.13-0.33 0.21-0.52 | 09 67 000 7576 09 67 000 5576 09 67 000 8576 | 09 67 000 7476 09 67 000 5476 09 67 000 8476 | <table border="1"> <thead> <tr> <th colspan="2">Wire gauge</th> <th>Stripping length</th> </tr> </thead> <tbody> <tr> <td>0,08-0,21 mm²</td> <td>AWG 28-24</td> <td>4 mm</td> </tr> <tr> <td>0,13-0,33 mm²</td> <td>AWG 26-22</td> <td>4 mm</td> </tr> <tr> <td>0,21-0,52 mm²</td> <td>AWG 24-20</td> <td>4 mm</td> </tr> </tbody> </table> | Wire gauge | | Stripping length | 0,08-0,21 mm ² | AWG 28-24 | 4 mm | 0,13-0,33 mm ² | AWG 26-22 | 4 mm | 0,21-0,52 mm ² | AWG 24-20 | 4 mm | |
| Wire gauge | | Stripping length | | | | | | | | | | | | | | | |
| 0,08-0,21 mm ² | AWG 28-24 | 4 mm | | | | | | | | | | | | | | | |
| 0,13-0,33 mm ² | AWG 26-22 | 4 mm | | | | | | | | | | | | | | | |
| 0,21-0,52 mm ² | AWG 24-20 | 4 mm | | | | | | | | | | | | | | | |

Order crimp contacts separately

Stock items in bold type

Features

- Well known Quintax concept
- Suitable for contacts with large diameters
- Han E® coax is applicable to the ETCS Eurobalise cable

RF transmission characteristics

Impedance 75 Ω

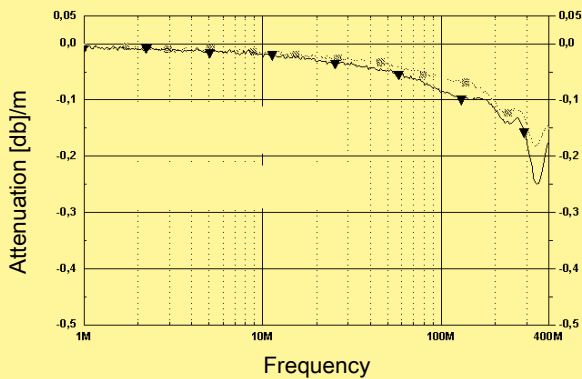

- 75 Ω cable
- 75 Ω cable with Han D® Coax
- 75 Ω coax cable diameter shielding: 7.3 mm

Impedance 50 Ω

| | |
|---|---------------|
| Han E® Coax with ETCS S21 Eurobalise cable (4 mm ²) | 27 MHz |
| Return loss [db] | 35.4 |
| Attenuation [db] | 0.017 |

| | | | | | | | |
|--|----------------|----------------|----------------|----------------|----------------|----------------|----------------|
| Han E® Coax with RG 213 cable (2.5 mm ²) | 200 MHz | 500 MHz | 1.0 GHz | 1.2 GHz | 1.5 GHz | 2.0 GHz | 2.5 GHz |
| Return loss [db] | 23.8 | 21.1 | >18.7 | >17.7 | >16.4 | >14.1 | >12.0 |
| Attenuation [db] | 0.07 | 0.11 | 0.17 | 0.2 | <0.23 | <0.53 | <2.0 |

Technical characteristics

Specifications DIN EN 60 664-1
DIN EN 61 984

Approvals

Inserts

Number of contacts 2

Insulation resistance $\geq 10^{10} \Omega$

Material polycarbonate

Limiting temperatures -40 °C ... +125 °C

Flammability acc. to UL 94 V 0

Mechanical working life - mating cycles ≥ 500

Coax contacts

Number of contacts 1 + shielding

Electrical data acc. to EN 61 984

- Han D® Coax **10 A 50 V 0.8 kV 3**

- Han E® Coax **16 A 50 V 0.8 kV 3**

Rated current 10 A / 16 A

Rated voltage 50 V

Rated impulse voltage 0.8 kV

Pollution degree 3

Impedance

- Han D® Coax 75 Ω

- Han E® Coax 50 Ω

Material

- Insulator polycarbonate

- Outer conductor zinc alloy

Contact resistance $\leq 4 \text{ m}\Omega$

Limiting temperatures -40 °C ... +85 °C

Flammability acc. to UL 94 V 0

Outer surface finish nickel

Cable diameter 3 ... 9.5 mm

Han D® contacts

Material copper alloy

Surface - hard-gold plated 2 μm Au over 3 μm Ni

Contact resistance $\leq 3 \text{ m}\Omega$

Crimp terminal - mm² 0.14 ... 2.5 mm²

- AWG 26 ... 14

Han E® contacts

Material copper alloy

Surface - hard-gold plated 2 μm Au over 3 μm Ni

Contact resistance $\leq 1 \text{ m}\Omega$

Crimp terminal - mm² 0.14 ... 5.5 mm²



- AWG 26 ... 10

Number of contacts

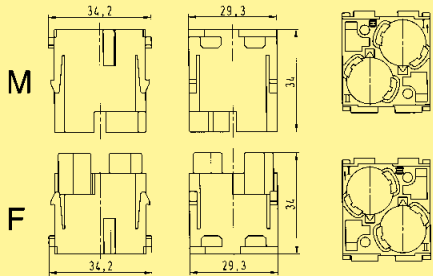
2

| Identification | Part number | | Drawing | Dimensions in mm |
|---|-----------------------|-----------------------|--|------------------|
| | Male insert (M) | Female insert (F) | | |
| Crimp terminal  | 09 14 002 3001 | 09 14 002 3101 |  <p>M</p> <p>F</p> <p>Contact arrangement view from termination side</p> | |

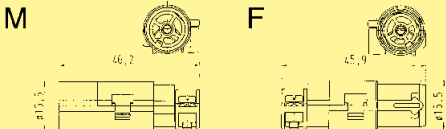
Han Modular

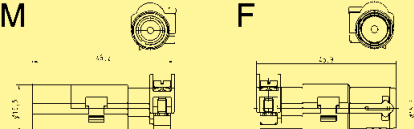
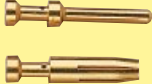
| Identification | Wire gauge (mm ²) | Part number | | Drawing | Dimensions in mm |
|--|---|---|---|---|------------------|
| | | Male contact | Female contact | | |
| Han® D Coax contact 1 + shielding, 75 Ω Han D® crimp contacts  | | 09 15 001 3013 | 09 15 001 3113 |  <p>M</p> <p>F</p> | |
| Han D® Crimp contact gold plated  | 0.14-0.37 0.5 0.75 1 1.5 2.5 | 09 15 000 6124 09 15 000 6123 09 15 000 6125 09 15 000 6122 09 15 000 6121 09 15 000 6126 | 09 15 000 6224 09 15 000 6223 09 15 000 6225 09 15 000 6222 09 15 000 6221 09 15 000 6226 | | |
| Han® E Coax contact 1 + shielding, 50 Ω Han E® crimp contacts  | | 09 15 001 3023 | 09 15 001 3123 |  <p>M</p> <p>F</p> | |
| Han E® contacts gold plated  | 0.14-0.37 0.5 0.75 1 1.5 2.5 4 5.5 | 09 33 000 6117 09 33 000 6122 09 33 000 6115 09 33 000 6118 09 33 000 6116 09 33 000 6123 09 33 000 6119 09 33 000 6139 | 09 33 000 6217 09 33 000 6222 09 33 000 6215 09 33 000 6218 09 33 000 6216 09 33 000 6223 09 33 000 6221 09 33 000 6239 | | |

Order crimp contacts separately

Stock items in bold type

Features

- Suitable for FOC and coaxial contacts acc. to DIN 41 626
- Using of guiding pins (male and female) is imperative (see chapter 40).

Contact arrangement

according to following matrix

| Contacts | Male insert (M) 09 14 004 4501 | Female insert (F) 09 14 004 4512 |
|------------------|-----------------------------------|-------------------------------------|
| Coaxial contacts | 09 14 000 62xx | 09 14 000 61xx |
| F.O. contacts | 20 10 xxx 421x | 20 10 xxx 422x |

Coaxial cables (group 2)

| Wires | Shell ∅ mm | Internal wire ∅ mm | Attenuation db/100 m at | | |
|--------------|------------------|-----------------------------|-------------------------|---------|---------|
| | | | 100 MHz | 200 MHz | 800 MHz |
| 50 Ω | | | | | |
| RG 174 / U | 2.5 | 0.48 | | | 84 |
| RG 188 A / U | 2.6 | 0.54 | 29 | 40 | |
| RG 316 / U | 2.5 | 0.54 | | 40 | |
| 75 Ω | | | | | |
| RG 179 B / U | 2.55 | 0.3 | | 41 | |
| RG 187 A / U | 2.7 | 0.3 | | 41 | |

Technical characteristics

Specifications DIN EN 60 664-1
DIN EN 61 984

Approvals

Inserts

Number of contacts 4
Insulation resistance $\geq 10^{10} \Omega$
Material polycarbonate
Limiting temperatures $-40 \text{ °C} \dots +125 \text{ °C}$
Flammability acc. to UL 94 V 0
Mechanical working life
- mating cycles ≥ 500

Contacts

Coaxial contacts

Material copper alloy
Surface
- hard-gold plated demand level 2
Impedance 50 Ω / 75 Ω
Contact resistance
- Internal wire $\leq 10 \text{ m}\Omega$
- Outer conductor $\leq 3 \text{ m}\Omega$
Rated current 1.5 A
Rated voltage 50 V

F.O. contacts

Fibre type Glas fibre (GI)
Attenuation < 1.5 dB

F.O. contacts

Fibre type Polymer Optical Fibre (POF)
Attenuation < 2.5 dB

Assembly instructions

Stripping de-
scription

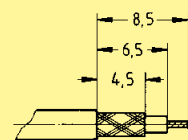

Assembly details
for coaxial contacts

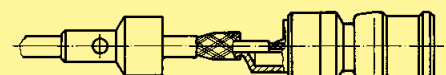

Crimp barrel solder

Solder temperature approx. 300 °C
Solder duration approx. 2 s

Due to the closed entry design of female insert the upper part has to be removed by screw driver (7 mm) before extracting the contacts. In this case the module will be destroyed.

Number of contacts

4

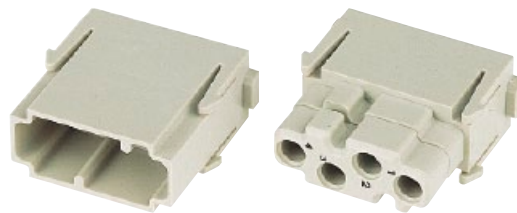

| Identification | Part number | | Drawing | Dimensions in mm |
|--|-----------------------|-----------------------|---|------------------|
| | Male insert (M) | Female insert (F) | | |
| Multi module acc. to DIN 41 626 Order contacts separately | 09 14 004 4501 | 09 14 004 4512 | <p>Contact arrangement view from termination side</p> | |

Han
Modular

| Identification | Impedance | Part number | | Drawing | Dimensions in mm |
|---|--------------|---|---|---|------------------|
| Coaxial contacts acc. to DIN 41 626* Solder / crimp contact | 50 Ω 75 Ω | 09 14 000 6211 09 14 000 6221 | 09 14 000 6111 09 14 000 6121 | <p>For cable group 2 flexible wires</p> | |
| F.O. contacts acc. to DIN 41 626 for SI fibre (HCS®) 200/230 μm for GI fibre 50/125 μm or 62.5/125 μm ceramic ferrule for 1 mm plastic fibre | | 20 10 230 4211 20 10 125 4212 20 10 001 4211 | 20 10 230 4221 20 10 125 4222 20 10 001 4221 | | |

* Using of guiding pins is imperative (see chapter 40).

Stock items in bold type

Features

- Suitable for coaxial contacts acc. to D-Sub (DIN 41 652)
- Using of guiding pins (male and female) is recommended (see chapter 40).

Technical characteristics

Specifications DIN EN 60 664-1
 DIN EN 61 984

Approvals  

Inserts

Number of contacts 4
 Insulation resistance $\geq 10^{10} \Omega$
 Material polycarbonate
 Limiting temperatures -40 °C ... +125 °C
 Flammability acc. to UL 94 V 0
 Mechanical working life
 - mating cycles ≥ 500

Contacts

Coaxial contacts
 Material copper alloy
 Surface
 - hard-gold plated demand level 2, S4
 Impedance 50 Ω / 75 Ω
 Contact resistance
 - Internal wire $\leq 10 \text{ m}\Omega$
 - Outer conductor $\leq 3 \text{ m}\Omega$
 Rated current 1.5 A
 Rated voltage 50 V

Contact arrangement

according to following matrix

| Contacts | Male insert (M) 09 14 004 4501 | Female insert (F) 09 14 004 4513 |
|------------------|-----------------------------------|-------------------------------------|
| Coaxial contacts | 09 14 000 62xx | 09 14 000 61xx |
| Coaxial contacts | 09 69 28x 5xxx | 09 69 18x 5xxx |

Number of contacts

4

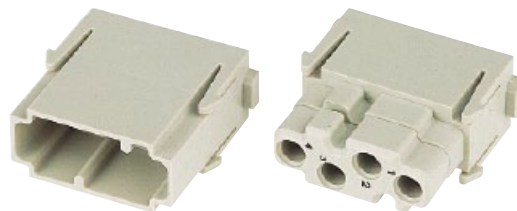

| Identification | Part number | | Drawing | Dimensions in mm |
|---|-----------------------|------------------------|---|------------------|
| | Male insert (M) | Female insert (F) | | |
| Multi module acc. to D-Sub Order contacts separately | 09 14 004 4501 | 09 14 004 4513* | <p>Contact arrangement view from termination side</p> | |

Han
Modular

| Identification | Impedance | Part number | | Drawing | Dimensions in mm |
|---|-----------|--|--|---------|------------------|
| Coaxial contacts acc. to D-Sub Performance level 2 Solder / solder contact | 50 Ω | 09 14 000 6215 | 09 14 000 6115 | | RG 58 |
| Solder / crimp contact Performance level S4 | | 50 Ω 09 69 281 5140 09 69 181 5140 50 Ω 09 69 281 5141 09 69 181 5141 50 Ω 09 69 281 5143 09 69 181 5143 75 Ω 09 69 281 5230 09 69 181 5230 | RG 174 U, 188 AU, 316 U RG 178 BU, 196 AU, 404 U RG 58 CU, 141 AU RG 179 BU, 187 AU | | |
| Crimp / crimp terminal Performance level S4 | | 50 Ω 09 69 282 5140 09 69 182 5140 75 Ω 09 69 282 5230 09 69 182 5230 | RG 174 U, 188 AU, 316 U RG 179 BU, 187 AU | | |

* Due to the closed entry design of female insert the upper part has to be removed by screw driver (7 mm) before extracting the contacts. In this case the module will be destroyed.

Stock items in bold type

Features

- Suitable for FOC and coaxial contacts acc. to DIN 41 626
- Using of guiding pins (male and female) is imperative (see chapter 40).

Contact arrangement

according to following matrix

| Contacts | Male insert (M) 09 14 004 4501 | Female insert (F) 09 14 004 4512 |
|------------------|-----------------------------------|-------------------------------------|
| Coaxial contacts | 09 14 000 62xx | 09 14 000 61xx |
| F.O. contacts | 20 10 xxx 421x | 20 10 xxx 422x |

Coaxial cables (group 2)

| Wires | Shell ∅ mm | Internal wire ∅ mm | Attenuation db/100 m at | | |
|--------------|------------------|-----------------------------|-------------------------|---------|---------|
| | | | 100 MHz | 200 MHz | 800 MHz |
| 50 Ω | | | | | |
| RG 174 / U | 2.5 | 0.48 | 29 | 40 | 84 |
| RG 188 A / U | 2.6 | 0.54 | | | |
| RG 316 / U | 2.5 | 0.54 | | | |
| 75 Ω | | | | | |
| RG 179 B / U | 2.55 | 0.3 | 41 | 41 | |
| RG 187 A / U | 2.7 | 0.3 | | | |

Technical characteristics

Specifications DIN EN 60 664-1
 DIN EN 61 984

Inserts

Number of contacts 12
 Insulation resistance $\geq 10^{10} \Omega$
 Material polycarbonate
 Limiting temperatures -40 °C ... +125 °C
 Flammability acc. to UL 94 V 0
 Mechanical working life
 - mating cycles ≥ 500

Contacts

Coaxial contacts

Material copper alloy
 Surface
 - hard-gold plated demand level 2
 Impedance 50 Ω / 75 Ω
 Contact resistance
 - Internal wire $\leq 10 \text{ m}\Omega$
 - Outer conductor $\leq 3 \text{ m}\Omega$
 Rated current 1.5 A
 Rated voltage 50 V

F.O. contacts

Fibre type glas fibre (GI)
 Attenuation < 1.5 dB

F.O. contacts

Fibre type polymer Optical Fibre (POF)
 Attenuation < 2.5 dB

Assembly instructions

Stripping de- scription

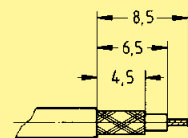

Assembly details for coaxial contacts

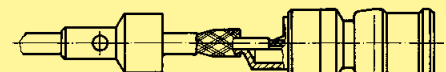

Crimp barrel solder

Solder temperature approx. 300 °C
 Solder duration approx. 2 s

Due to the closed entry design of female insert the upper part has to be removed by screw driver before extracting the contacts.

Number of contacts

4

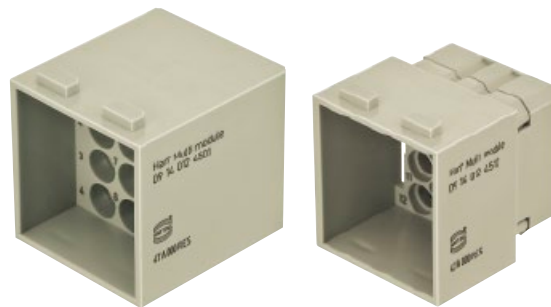

| Identification | Part number | | Drawing | Dimensions in mm |
|--|-----------------|-------------------|---------|---|
| | Male insert (M) | Female insert (F) | | |
| Multi module acc. to DIN 41 626 Order contacts separately | 09 14 012 4501 | 09 14 012 4512 | | Contact arrangement view termination side |

Han
Modular

| Identification | Impedance | Part number | | Drawing | Dimensions in mm |
|--|--------------|----------------------------------|----------------------------------|---------|----------------------------------|
| | | | | | |
| Coaxial contacts acc. to DIN 41 626* Solder / crimp contact | 50 Ω 75 Ω | 09 14 000 6211 09 14 000 6221 | 09 14 000 6111 09 14 000 6121 | | For cable group 2 flexible wires |
| F.O. contacts acc. to DIN 41 626* for SI fibre (HCS®) 200/230 μm for GI fibre 50/125 μm or 62.5/125 μm ceramic ferrule for 1 mm plastic fibre | | 20 10 230 4211 | 20 10 230 4221 | | |

* Usage of guiding pins is imperative (see chapter 40).

Features

- For the transmission of clean and dry compressed
- Female contacts with / without shut off
- Removal of tubes from pre-assembled pneumatic contacts is possible

Shut off principle:

In the disconnected position the spring integrated in the female contact is active, thus the O-ring of the valve seals the opening of the air-way. During the mating process, when the defined depth of insertion is reached the male contact presses on the valve head and moves it backwards against the spring tension, so that the air-way opens.

Using of guiding pins in connection with pneumatic modules is imperative.

In addition to this guiding pins guarantee a coding, if pneumatic modules are used exclusively.

Technical characteristics

Approvals 

Inserts *

| | |
|--|-------------------|
| Number of contacts | 2 |
| Colour | blue |
| Material | polycarbonate |
| Limiting temperatures | -40 °C ... +80 °C |
| Flammability acc. to UL 94 | V 0 |
| Mechanical working life - mating cycles | ≥ 500 |

Contacts

| | |
|--|-----------------------|
| Material | delrin acetal |
| Colour | black |
| Tube termination - Internal diameter (ID) | 6.0 mm / 1/4" |
| Working pressure | up to 8 bar / 116 psi |

Sealing

| | |
|----------|--------|
| Material | Buna-N |
|----------|--------|

Shut off valve

| | |
|----------|--------------|
| Material | Polypropylen |
|----------|--------------|

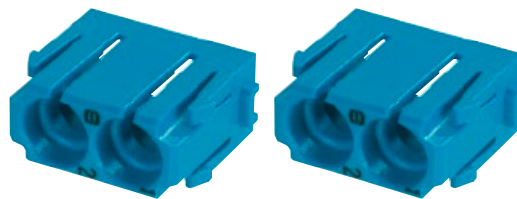

Number of contacts

2

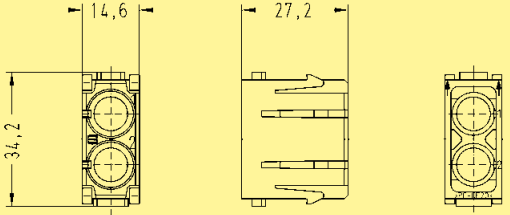

| Identification | Part number | | Drawing | Dimensions in mm |
|--|------------------------|------------------------|--|------------------|
| | Male insert (M) | Female insert (F) | | |
| for 6 mm Order contacts separately  | 09 14 002 4501* | 09 14 002 4501* |  <p>Contact arrangement view from termination side</p> | |

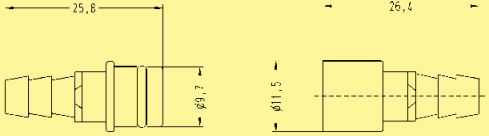
Han Modular

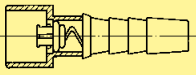
| Identification | ID (mm) | Part number | | Drawing | Dimensions in mm |
|---|---------|-----------------------|-----------------------|---|------------------|
| | | Male contact | Female contact | | |
| Pneumatic contacts without shut off for tube internal diameter (ID)  | 6.0 | 09 14 000 6174 | 09 14 000 6274 |  <p>Male contact Female contact</p> | |
| Pneumatic contacts with shut off for tube internal diameter (ID)  | 6.0 | | 09 14 000 6279 |  <p>female contact with shut off in closed position</p> | |

* Using of guiding pins is imperative (see chapter 40).

Stock items in bold type

Features

- For the transmission of clean and dry compressed
- Female contacts with / without shut off
- Removal of tubes from pre-assembled pneumatic contacts is possible

Shut off principle:

In the disconnected position the spring integrated in the female contact is active, thus the O-ring of the valve seals the opening of the air-way. During the mating process, when the defined depth of insertion is reached the male contact presses on the valve head and moves it backwards against the spring tension, so that the air-way opens.

Using of guiding pins in connection with pneumatic modules is imperative.

In addition to this guiding pins guarantee a coding, if pneumatic modules are used exclusively.

Technical characteristics

Approvals 

Inserts *

| | |
|--|-------------------|
| Number of contacts | 3 |
| Colour | blue |
| Material | polycarbonate |
| Limiting temperatures | -40 °C ... +80 °C |
| Flammability acc. to UL 94 | V 0 |
| Mechanical working life - mating cycles | ≥ 500 |

Contacts

| | |
|--------------------------|---|
| Material | delrin acetal |
| Colour | black |
| Tube termination | |
| - Internal diameter (ID) | 1.6 mm / 1/16" 3.0 mm 4.0 mm / 1/8" |
| Working pressure | up to 8 bar / 116 psi |

Sealing

| | |
|----------|--------|
| Material | Buna-N |
|----------|--------|

Shut off valve

| | |
|----------|--------------|
| Material | Polypropylen |
|----------|--------------|

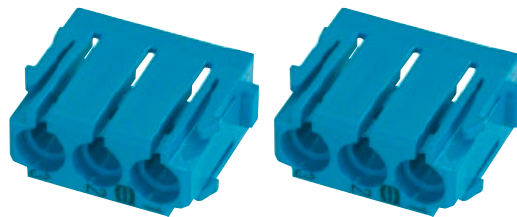

Number of contacts

3

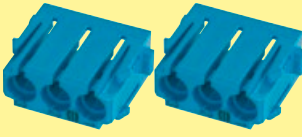
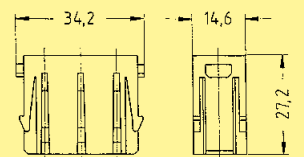

| Identification | Part number | | Drawing | Dimensions in mm |
|--|------------------------|------------------------|--|------------------|
| | Male insert (M) | Female insert (F) | | |
| for 1.6; 3; 4 mm Order contacts separately  | 09 14 003 4501* | 09 14 003 4501* |  <p>Contact arrangement view from termination side</p> | |

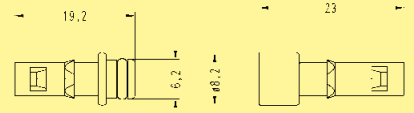
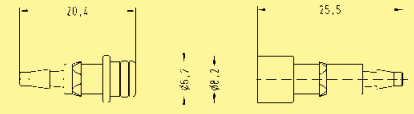
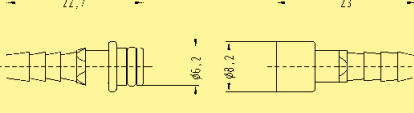
Han Modular

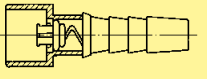
| Identification | ID (mm) | Part number | | Drawing | Dimensions in mm |
|---|-------------------|-----------------------|---|--|------------------|
| | | Male contact | Female contact | | |
| Pneumatic contacts without shut off for tube internal diameter (ID)  | 1.6 | 09 14 000 6151 | 09 14 000 6251 |  | |
| | 3.0 | 09 14 000 6152 | 09 14 000 6252 |  | |
| | 4.0 | 09 14 000 6153 | 09 14 000 6253 |  | |
| Pneumatic contacts with shut off for tube internal diameter (ID)  | 1.6 3.0 4.0 | | 09 14 000 6256 09 14 000 6257 09 14 000 6258 |  <p>female contact with shut off in closed position</p> | |

* Using of guiding pins is imperative (see chapter 40).

Stock items in bold type

Features

- Suitable for HARTING SC contacts
- For GI-Fibre 50 - 62.5 / 125µm
- Using of guiding pins (male and female) is recommended (see chapter 40).

Technical characteristics

Approvals



Inserts

| | |
|----------------------------|-------------------|
| Number of contacts | 4 |
| Insertion loss | < 0.5 dB |
| Material | polycarbonate |
| Limiting temperatures | -40 °C ... +85 °C |
| Flammability acc. to UL 94 | V 0 |
| Mechanical working life | |
| - mating cycles | ≥ 500 |

Han
Modular

Assembly instructions

Male insert (09 14 004 4701)

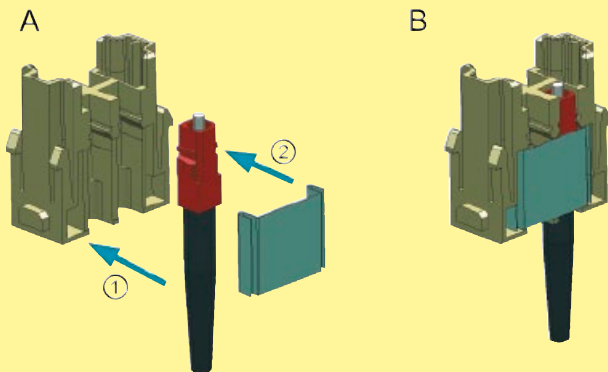

A Assemble the SC contact

Push the SC contact from the side into the relevant insert (1)
Push the fixing plate from the side over the contacts (2)

B SC contact fixed in the module

Female insert (09 14 004 4711)

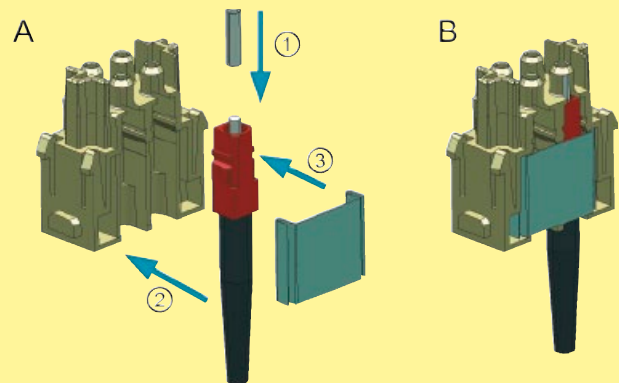

A Assemble the SC contact



Push the centering ferrule (included in delivery) on the SC contact (1)
Push the SC contact from the side into the relevant insert (2)
Push the fixing plate from the side over the contacts (3)

B SC contact fixed in the module

Number of contacts

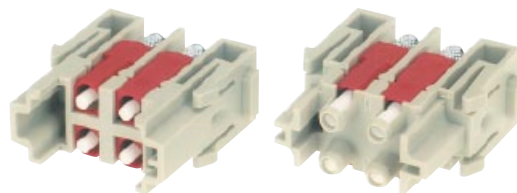
4

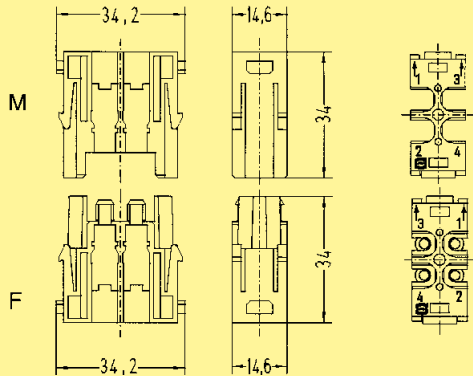

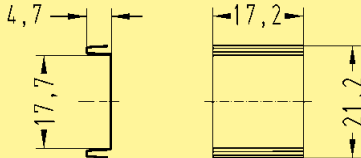
| Identification | Part number | | Drawing | Dimensions in mm |
|---|-----------------------|------------------------|--|------------------|
| | Male insert (M) | Female insert (F) | | |
| <p>SC module</p> <p>Order contacts separately</p>  | 09 14 004 4701 | 09 14 004 4711* |  <p>Contact arrangement view from termination side</p> | |
| <p>Fixing plate</p>  | 09 14 000 9965 | 09 14 000 9965 |  | |

Han Modular

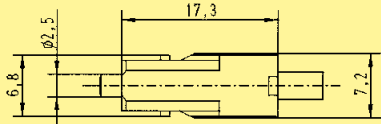
| Identification | Part number | | Drawing | Dimensions in mm |
|--|-----------------------|-----------------------|---|------------------|
| | Male contact | Female contact | | |
| <p>SC contact</p> <p>for GI fibre 50/125 µm or 62.5/125 µm ceramic ferrule</p>  | 20 10 125 5211 | 20 10 125 5211 |  | |
| <p>for SI fibre (HCS®) 200/230 µm</p> | 20 10 230 5211 | 20 10 230 5211 | | |
| <p>with quick assembly technique for 1 mm POF</p> | 20 10 001 5217 | 20 10 001 5217 | | |
| <p>with crimp technique for 1 mm POF</p> | 20 10 001 5211 | 20 10 001 5211 | | |

* The female inserts are equipped with centering ferrules.
4 ferrules are included in delivery range.

Stock items in bold type

Features

- Signal pre-processing and conversion do fit into the connector
- Individual combination of input and output modules for optimal signal pre-processing
- Minimum size for integration in Han® industrial connectors (Han-Modular® and Han-Snap®)
- Economy of space by reduction the number of terminal blocks and interface modules in the switch cabinet

Technical characteristics

Power supply

(combination input and output module)

| | |
|--------------------------|------------------------|
| Supply voltage | 24 V (-10 % ... +25 %) |
| Current consumption | < 0.08 A |
| Power consumption | < 2 W |
| Total transmission error | < 0.2 % |

Han
Modular

General description

The Han-Elisa® modules are a flexible I/O system - directly in the connector.

The input and output modules are developed for 1 or 2 channels and can be combined variously and flexible for optimal signal pre-processing. Within the product family modules are available for current/voltage conversion, temperature, relay and timer.

Due to the minimized size these modules can be integrated into the Han-Modular® and Han-Snap® system.

Signal pre-processing and conversion do fit into the connector and this will reduce installation space for terminal blocks and the number of interface modules. So the switch cabinets can be made smaller.

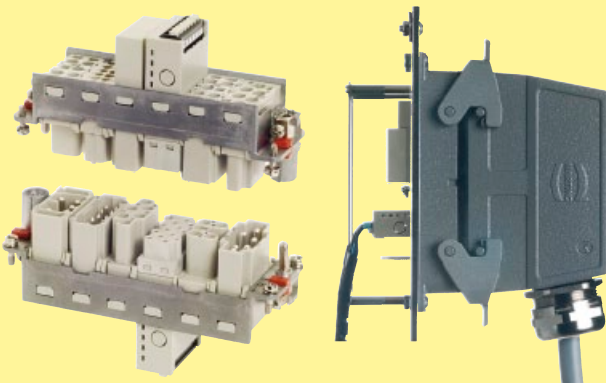

Product matrix and possible combinations

| input module (male) | output module (female) | Relay Different versions | Optocoupler Different versions | Output current 4 ... 20 mA galvanically isolated | Output voltage 0 ... 10 V galvanically isolated |
|---|------------------------|-----------------------------|-----------------------------------|--|---|
| Timing | | ○ | ○ | | |
| Connecting 1:1 | | ○ | ○ | | |
| Temperature Pt100 Different temperature ranges | | | | ● | ● |
| Temperature thermo element type J, K Different temperature ranges | | | | ○ | ○ |
| Input current 4 ... 20 mA | | | | ○ | ○ |
| Input voltage 0 ... 10 V | | | | ○ | ○ |

○ = on request
● = available

Features

- Minimum size for integration in Han® industrial connectors (Han-Modular® and Han-Snap®)
- Economy of space by reduction the number of terminal blocks and interface modules in the switch cabinet
- Male module for signal input

Technical characteristics

Inserts

| | |
|--|---------------------------|
| Sensor | Pt100 acc. to IEC 751 |
| Termination technology | 2-, 3-, 4 wire technology |
| Sensor input current | 0.8 mA, constant |
| Conductor resistance, max. permissible | 10 Ω per conductor |
| Min. measuring range | 100 °C |
| Open circuit detection | integrated |

| | |
|-------------------|------------------------------|
| Material | polycarbonate / LCP |
| Termination | Cage-clamp terminal |
| - mm ² | 0.14 ... 1.5 mm ² |
| - AWG | 26 ... 16 |

| | |
|------------------|-------------|
| Power diagnostic | LED (green) |
|------------------|-------------|

Temperature range

| | |
|---------------------|-------------------|
| Working temperature | -20 °C ... +65 °C |
| Stock temperature | -40 °C ... +85 °C |



Pt100 Input module

| Identification | | Part number Male insert (M) | Drawing | Dimensions in mm |
|--|--------------|--------------------------------|---------|------------------|
| Temperature module Pt100 | | | | |
| Measuring range | 0 ... 100 °C | 20 75 108 1101 | | |
| | 0 ... 200 °C | 20 75 108 1103 | | |
| Additional measuring ranges on request | | | | |

Han
Modular

Features

- Minimum size for integration in Han[®] industrial connectors (Han-Modular[®] and Han-Snap[®])
- Economy of space by reduction the number of terminal blocks and interface modules in the switch cabinet
- Female module for signal output

Technical characteristics

Inserts

| | |
|----------------------------|-------------------------|
| Supply voltage | 24 V (-10 % ... +25 %) |
| Load I_{out} | < 500 Ω |
| Load U_{out} | \geq 10 k Ω |
| Residual ripple | < 20 mV (500 Ω) |
| Step response (0 ... 99 %) | < 30 ms |

| | |
|-------------------|------------------------------|
| Material | polycarbonate / LCP |
| Termination | Cage-clamp terminal |
| - mm ² | 0.14 ... 1.5 mm ² |
| - AWG | 26 ... 16 |

| | |
|------------------|-------------|
| Power diagnostic | LED (green) |
|------------------|-------------|

Temperature range

| | |
|---------------------|--------------------|
| Working temperature | -20 °C ... +65 °C |
| Stock temperature | -40 °C ... +125 °C |



Output module

| Identification | Part number Female insert (F) | Drawing | Dimensions in mm |
|---|----------------------------------|---------|------------------|
| <p>Output module, current 3-ways-isolating amplifier; galvanically isolated</p> <p>Output signal 4 ... 20 mA</p> <p>Additional output signal ranges on request</p> | 20 75 104 2201 | | |
| <p>Output module, voltage 3-ways-isolating amplifier; galvanically isolated</p> <p>Output signal 0 ... 10 V</p> <p>Additional output signal ranges on request</p> | 20 75 105 2201 | | |

Han
Modular

Features

- Coding of tools possible (e.g. press tools) by means of an alphanumeric identification
- I²C bus EEPROM as memory medium
- Communication with PLC via conventional digital I/Os
- Physical connection of PLC by means of well-proven Han® contacts
- Assembly of the ID module to the device by means of a Han® industrial connector

Technical characteristics

Inserts

| | |
|--|---|
| Supply voltage | 24 V |
| Electrical connector, 24 V | via digital I/O device Han E® module (see page 06.42) |
| Memory capacity | max. 128 Byte |
| Material | polycarbonate |
| Working temperature | 0 °C ... +70 °C |
| Stock temperature | 0 °C ... +85 °C |
| Max. length recommended between I/O device and ID module | 100 m * |

Han
Modular

General description

The HARTING connector identification module (ID module) is suitable for storing of data and for coding of connectors. It is integrated in a Han-Modular® standard E module.

The module can be connected to a 24 V digital I/O device of a PLC. Two digital inputs are used for detecting the module connection and the data input. Two digital outputs are used for the data output and the system clock. Furthermore the ID module must be connected with 24 V and GND. Communication is carried out with voltage levels of 24 V according to the I²C bus standard. The total memory capacity is 128 Byte, e.g. for storing part numbers to identify the module. It is also possible to store the start parameters or operating data for machine components.

A typical data structure is displayed in the following table:

Byte no.

| | | | | | | | | | | | | | | | |
|-----------|----|-------------------------|----|----|----|-----------------------------|---|---|---|-------------------------|---|---|---|---|---|
| 16 | 15 | 14 | 13 | 12 | 11 | 10 | 9 | 8 | 7 | 6 | 5 | 4 | 3 | 2 | 1 |
| Check sum | | Operating hours of tool | | | | Start parameter of the unit | | | | Part number of the unit | | | | | |

Applications for the ID module can be found in modular machines and product lines. A great advantage of the ID module is the non volatile decentralized storing of e.g. operating data. When changing the location stored data can protect the machines from damages. In service cases of the equipment data can be analyzed to minimize service time.



Input module

| Identification | Part number Male insert (M) | Drawing | Dimensions in mm |
|----------------------------------|--------------------------------|---------|------------------|
| Electronic identification module | 20 70 001 1001 | | |





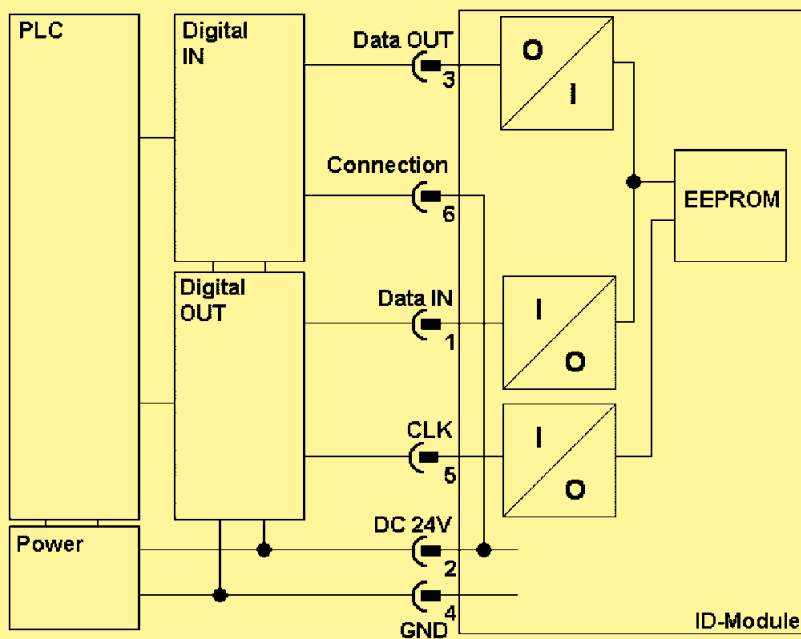

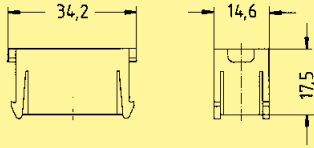

Han
Modular

Block diagram / Wiring plan

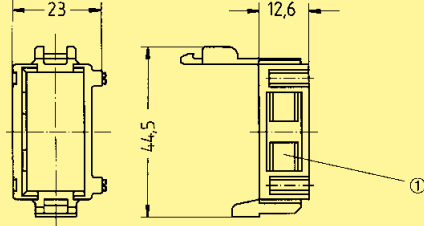

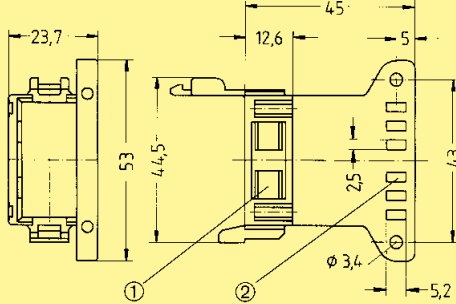
Meaning of the connections

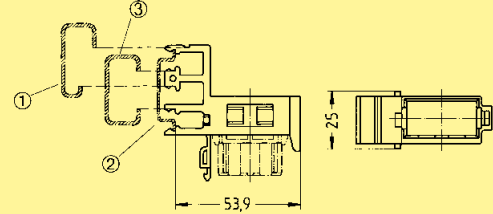
| Pin no. | Name | Meaning/Function |
|---------|------------|--|
| 1 | Data IN | Input for data and control signals from PLC |
| 2 | DC 24 V | Power connection of the ID module |
| 3 | Data OUT | Output for data signals from ID module to PLC |
| 4 | GND | Ground |
| 5 | CLK | System clock for synchronisation |
| 6 | Connection | Output of the ID module for connection detection |

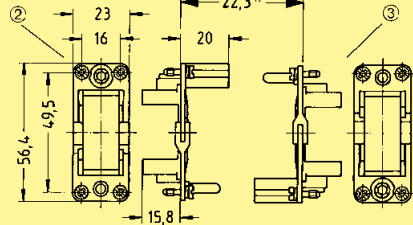
| Identification | Part number | Drawing | Dimensions in mm |
|--|------------------------------|---|------------------|
| <p>Han-Modular® Dummy module to fill up module spaces not in use in the frame</p>  | <p>09 14 000 9950</p> |  | |
| <p>Module clamp without strain relief *</p>  <p>Delivery comprises one module clamp.</p> | <p>09 14 000 0311</p> |  <p>1 Slot for identification strip</p> | |
| <p>Module clamp with strain relief *</p>  <p>Delivery comprises one module clamp.</p> | <p>09 14 000 0312</p> |  <p>1 Slot for identification strip 2 For cable ties with max. 5 mm width</p> | |
| <p>Module clamp for rail *</p>  <p>Delivery comprises one module clamp.</p> | <p>09 14 000 0313</p> |  <p>1 G-rail DIN EN 60 715-G32 2 rail DIN EN 60 715-35 x 7.5 with 1 mm thickness or -35 x 15 with 1.5 mm thickness 3 C-rail DIN EN 60 715-C30</p> | |
| <p>Frame for 1 module</p>  <p>in housing Han® 10 A</p> | <p>09 14 000 0304</p> |  <p>1 Distance max. 23.5 mm 2 Hoods 3 Housings</p> | |
| | | | |

* Suitable for the single modules Han® C Crimp, Han® C Axial, Han E® Crimp, Han EE®, Han E® Protected, Han DD® Crimp, Han® High Density, Han® USB, Han® Firewire, Han® Multi module and Han® SC